

NIST NCSTAR 1-6B

**Federal Building and Fire Safety Investigation of the
World Trade Center Disaster**

Fire Resistance Tests of Floor Truss Systems

John Gross
Frederick Hervey
Mark Izydorek
John Mammoser
Joseph Treadway

NIST NCSTAR 1-6B

**Federal Building and Fire Safety Investigation of the
World Trade Center Disaster**

**Fire Resistance Tests of
Floor Truss Systems**

John Gross
*Building and Fire Research Laboratory
National Institute of Standards and Technology*

Frederick Hervey
Mark Izydorek
John Mammoser
Joseph Treadway
Underwriters Laboratories, Inc.

September 2005



U.S. Department of Commerce
Carlos M. Gutierrez, Secretary

Technology Administration
Michelle O'Neill, Acting Under Secretary for Technology

National Institute of Standards and Technology
William Jeffrey, Director

Disclaimer No. 1

Certain commercial entities, equipment, products, or materials are identified in this document in order to describe a procedure or concept adequately or to trace the history of the procedures and practices used. Such identification is not intended to imply recommendation, endorsement, or implication that the entities, products, materials, or equipment are necessarily the best available for the purpose. Nor does such identification imply a finding of fault or negligence by the National Institute of Standards and Technology.

Disclaimer No. 2

The policy of NIST is to use the International System of Units (metric units) in all publications. In this document, however, units are presented in metric units or the inch-pound system, whichever is prevalent in the discipline.

Disclaimer No. 3

Pursuant to section 7 of the National Construction Safety Team Act, the NIST Director has determined that certain evidence received by NIST in the course of this Investigation is “voluntarily provided safety-related information” that is “not directly related to the building failure being investigated” and that “disclosure of that information would inhibit the voluntary provision of that type of information” (15 USC 7306c).

In addition, a substantial portion of the evidence collected by NIST in the course of the Investigation has been provided to NIST under nondisclosure agreements.

Disclaimer No. 4

NIST takes no position as to whether the design or construction of a WTC building was compliant with any code since, due to the destruction of the WTC buildings, NIST could not verify the actual (or as-built) construction, the properties and condition of the materials used, or changes to the original construction made over the life of the buildings. In addition, NIST could not verify the interpretations of codes used by applicable authorities in determining compliance when implementing building codes. Where an Investigation report states whether a system was designed or installed as required by a code *provision*, NIST has documentary or anecdotal evidence indicating whether the requirement was met, or NIST has independently conducted tests or analyses indicating whether the requirement was met.

Use in Legal Proceedings

No part of any report resulting from a NIST investigation into a structural failure or from an investigation under the National Construction Safety Team Act may be used in any suit or action for damages arising out of any matter mentioned in such report (15 USC 281a; as amended by P.L. 107-231).

**National Institute of Standards and Technology National Construction Safety Team Act Report 1-6B
Natl. Inst. Stand. Technol. Natl. Constr. Sfty. Tm. Act Rpt. 1-6B, 202 pages (September 2005)
CODEN: NSPUE2**

U.S. GOVERNMENT PRINTING OFFICE
WASHINGTON: 2005

For sale by the Superintendent of Documents, U.S. Government Printing Office
Internet: bookstore.gpo.gov — Phone: (202) 512-1800 — Fax: (202) 512-2250
Mail: Stop SSOP, Washington, DC 20402-0001

ABSTRACT

The National Institute of Standards and Technology (NIST) review of available documents related to the design and construction of the World Trade Center (WTC) towers indicated that the fire performance of the composite floor system of the WTC towers was an issue of concern to the building owners and designers from the original design and throughout the service life of the buildings. However, NIST found no evidence that fire resistance tests of the WTC floor system were ever conducted. As a result, NIST conducted a series of four standard fire resistance tests (ASTM E 119). In this series of tests, the effects of three factors were studied: (1) thickness of sprayed fire-resistive material (SFRM), (2) test restraint conditions, and (3) scale of the test. The tests were conducted by Underwriters Laboratories, Inc. under a NIST contract and represented both full-scale (35 ft span) and reduced-scale (17 ft span) floor assemblies constructed to represent the original design as closely as practical. For three of the tests, the thickness of the sprayed fire resistive material was $\frac{3}{4}$ in. which represented the average thickness applied in the original construction. In the fourth test, the thickness of applied SFRM was $\frac{1}{2}$ in. which was the thickness specified for the original design. Tests were conducted in both the restrained and unrestrained condition to provide bounds on the expected performance of the floor system under the standard fire exposure. The restrained full-scale floor system obtained a fire resistance rating of $1\frac{1}{2}$ h, while the unrestrained floor system achieved a 2 h rating. For the unrestrained test condition, specimens protected with $\frac{3}{4}$ in. thick sprayed fire resistive material were able to sustain the maximum design load for approximately 2 h without collapsing; in the unrestrained test, the load was maintained without collapsing for $3\frac{1}{2}$ h. Past experience with the ASTM E 119 test method would lead investigators to expect that the unrestrained floor assembly would not perform as well as the restrained assembly, and therefore, would receive a lower fire rating. A fire rating of 2 h was determined from the reduced-scale test with the average applied SFRM thickness of $\frac{3}{4}$ in., while a fire rating of $1\frac{1}{2}$ h was determined from the full-scale test with the same SFRM thickness. This finding raises the question of whether or not a fire rating based on the ASTM E 119 performance of a 17 ft span floor assembly is scalable to a larger floor system such as found in the WTC towers where spans ranged from 35 ft to 60 ft.

Keywords: ASTM E 119, fire testing, floor systems, sprayed fire-resistive materials, standard fire test, steel, structural behavior, testing, trusses, World Trade Center.

This page intentionally left blank.

TABLE OF CONTENTS

Abstract	iii
List of Figures	ix
List of Tables	xiii
List of Acronyms and Abbreviations	xv
Preface	xvii
Acknowledgments	xxvii
Executive Summary	xxix
Chapter 1	
Introduction	1
1.1 Motivation for Conducting Standard Fire Tests of the WTC Floor System	1
1.2 Purpose of the Standard Fire Tests	2
1.3 Test Variables	2
1.3.1 SFRM Thickness	2
1.3.2 Restraint Conditions	3
1.3.3 Scale	3
1.4 Test Program	3
Chapter 2	
ASTM Standard Fire Test	5
2.1 General Description	5
2.2 Restraint Conditions	5
2.3 Conditions of Acceptance	5
Chapter 3	
Description of WTC Floor System and SFRM	7
3.1 Composite Slab Floor System	7
3.2 Steel Trusses	7
3.3 SFRM Thickness	8
Chapter 4	
Floor Test Assemblies	9
4.1 Design of Tests	9
4.1.1 Span of Test Assembly	9

4.1.2	Geometric Scaling of Floor Trusses	9
4.1.3	Concrete Slab Thickness	10
4.1.4	Steel Truss Sections.....	10
4.1.5	Applied Load	10
4.2	Materials of Construction	11
4.2.1	Fabrication of Trusses	11
4.2.2	Steel Grade	12
4.2.3	Truss Welds.....	12
4.2.4	Metal Deck	14
4.2.5	Welded Wire Fabric	21
4.2.6	Concrete.....	21
4.2.7	Primer	21
4.2.8	Sprayed Fire-Resistive Materials	21
4.2.9	Miscellaneous Steel.....	21
4.3	Construction of Test Assemblies	22
4.3.1	Construction of 35 Ft Assemblies	22
4.3.2	Construction of 17 Ft Assemblies	35
4.4	Loading of Test Assemblies.....	43
4.4.1	Loading of 35 Ft Assemblies.....	43
4.4.2	Loading of 17 Ft Assemblies.....	44
4.5	Instrumentation	46
4.5.1	Deflection Instrumentation.....	46
4.5.2	Furnace Thermocouples	46
4.5.3	Radiometers.....	47
 Chapter 5		
	Test Results.....	49
5.1	Fire Test of Assembly No. 1	49
5.1.1	Test Observations	49
5.1.2	Data	51
5.1.3	Post-Test Observations.....	57
5.2	Fire Test of Assembly No. 2.....	63
5.2.1	Test Observations	63
5.2.2	Data	64
5.2.3	Post-Test Observations.....	71

5.3	Fire Test of Assembly No. 3	73
5.3.1	Test Observations	73
5.3.2	Data	75
5.3.3	Post-Test Observations	81
5.4	Fire Test of Assembly No. 4	83
5.4.1	Test Observations	83
5.4.2	Data	85
5.4.3	Post-Test Observations	91
5.5	Fire Resistance Ratings	94
5.5.1	Test Assembly No. 1	94
5.5.2	Test Assembly No. 2	94
5.5.3	Test Assembly No. 3	94
5.5.4	Test Assembly No. 4	95
5.5.5	Summary Table	95
 Chapter 6		
	Discussion of Results	97
6.1	Comparison of Results	97
6.1.1	Furnace Control Temperatures	97
6.1.2	Furnace Thermal Environment	98
6.1.3	Steel Temperatures	100
6.1.4	Unexposed Surface Temperatures	104
6.1.5	Deflections of Floor Assembly	104
6.2	Observations	105
6.3	Areas of Further Study	106
 Chapter 7		
	References	107
 Appendix A		
	Certified Mill Test Reports (CMTRs)	
 Appendix B		
	Primer Paint Specification	
 Appendix C		
	Construction Drawings for 35 Ft Test Assemblies	

Appendix D
Instrumentation for 35 Ft Test Assemblies

Appendix E
Construction Drawings for 17 Ft Test Assemblies

Appendix F
Instrumentation for 17 Ft Test Assemblies

Appendix G
Truss Calculation Sheets

Appendix H
Unreliable Data

Appendix I
Units Conversions

LIST OF FIGURES

Figure P-1. The eight projects in the federal building and fire safety investigation of the WTC disaster	xix
Figure 3-1. Floor system of the WTC towers.	7
Figure 4-1. 35 ft main truss, column end.	15
Figure 4-2. 35 ft main truss, core end.	16
Figure 4-3. 17 ft main truss, column end.	17
Figure 4-4. 17 ft main truss, core end.	18
Figure 4-5. Bridging truss for Assemblies Nos. 1 and 2.	19
Figure 4-6. Bridging truss for Assemblies Nos. 3 and 4.	20
Figure 4-7. Structural steel frame of Assembly No. 1.	23
Figure 4-8. Restrained end condition of Assembly No. 1 prior to shimming.	23
Figure 4-9. Unrestrained end condition of Assembly No. 2.	24
Figure 4-10. Intersection of deck support angle and main truss.	25
Figure 4-11. Cover plates on main truss.	26
Figure 4-12. Intersection of main and bridging truss, bottom chord.	26
Figure 4-13. Detail of rebar welded to end stiffener.	27
Figure 4-14. Placement of steel form deck.	28
Figure 4-15. Chairs for welded wire fabric.	29
Figure 4-16. Welded wire fabric.	29
Figure 4-17. Concrete placement.	30
Figure 4-18. Sandblasted assembly.	31
Figure 4-19. Primer on bridging truss.	31
Figure 4-20. Peened thermocouples on truss.	32
Figure 4-21. SFRM on main truss.	34
Figure 4-22. Measurement of SFRM thickness on truss chord.	34
Figure 4-23. Steel framing of 17 ft assembly.	36
Figure 4-24. Intersection of main truss and deck support angle.	37
Figure 4-25. Intersection of main and bridging truss bottom chord.	37
Figure 4-26. Cover plate detail.	38
Figure 4-27. Steel floor deck placement.	38

Figure 4–28. Chairs on steel deck.....	39
Figure 4–29. Welded wire fabric and rebar.....	40
Figure 4–30. View of radiometer and plate thermocouple.....	48
Figure 5–1. Assembly No. 1 – average and maximum individual temperatures on north main truss.....	51
Figure 5–2. Assembly No. 1 – average and maximum individual temperatures on south main truss.....	52
Figure 5–3. Assembly No. 1 – overall average and maximum individual temperatures on north and south main trusses.....	52
Figure 5–4. Assembly No. 1 – average and maximum individual temperatures on west bridging truss.....	53
Figure 5–5. Assembly No. 1 – average and maximum individual temperatures on east bridging truss.....	53
Figure 5–6. Assembly No. 1 – average and maximum individual temperatures on unexposed surface.....	54
Figure 5–7. Assembly No. 1 – average temperatures on steel deck.....	54
Figure 5–8. Assembly No. 1 – bottom chord deflection measurements.....	55
Figure 5–9. Assembly No. 1 – temperatures of bottom chord deflection rods.....	55
Figure 5–10. Assembly No. 1 – unexposed surface deflection measurements.....	56
Figure 5–11. Assembly No. 1 – additional instrumentation through west opening.....	56
Figure 5–12. Assembly No. 1 – additional instrumentation through east opening.....	57
Figure 5–13. Unexposed surface of Assembly No. 1 after loading equipment was removed.....	58
Figure 5–14. Detail of spalling concrete at west end of Assembly No. 1.....	59
Figure 5–15. Detail of spalling concrete at east end of Assembly No. 1.....	59
Figure 5–16. Close-up of spalling concrete at east end of Assembly No. 1.....	60
Figure 5–17. View looking east of the exposed side of Assembly No. 1– south main truss seen at right side.....	60
Figure 5–18. Intersection of north main and east bridging trusses on Assembly No. 1.....	61
Figure 5–19. View of core-end diagonal strut of south main truss on Assembly No. 1.....	61
Figure 5–20. Sections cut through concrete slab to confirm delamination spalling.....	62
Figure 5–21. Measurement of depth of delamination spalling.....	62
Figure 5–22. Assembly No. 2 – average and maximum individual temperatures on north main truss.....	65
Figure 5–23. Assembly No. 2 – average and maximum individual temperatures on south main truss.....	65
Figure 5–24. Assembly No. 2 – overall average and maximum individual temperatures on north and south main trusses.....	66

Figure 5–25. Assembly No. 2 – average and maximum individual temperatures on west bridging truss.....	66
Figure 5–26. Assembly No. 2 – average and maximum individual temperatures on east bridging truss.....	67
Figure 5–27. Assembly No. 2 – average and maximum individual temperatures on unexposed surface.....	67
Figure 5–28. Assembly No. – 2 average temperatures on steel deck.....	68
Figure 5–29. Assembly No. 2 bottom chord deflection measurements.....	68
Figure 5–30. Assembly No. 2 temperatures of bottom chord deflection rods.....	69
Figure 5–31. Assembly No. 2 – unexposed surface deflection measurements.....	69
Figure 5–32. Assembly No. 2 – additional instrumentation through west opening.....	70
Figure 5–33. Assembly No. 2 – additional instrumentation through east opening.....	70
Figure 5–34. Unexposed surface of Assembly No. 2 after loading equipment was removed.....	71
Figure 5–35. View of core end diagonal strut of north main truss on Assembly No. 2.....	72
Figure 5–36. South main truss of Assembly No. 2, looking east.....	72
Figure 5–37. Intersection of east bridging and north main trusses on Assembly No. 2.....	73
Figure 5–38. Assembly No. 3 – average and maximum individual temperatures on west main truss.....	75
Figure 5–39. Assembly No. 3 – average and maximum individual temperatures on east main truss.....	76
Figure 5–40. Assembly No. 3 – overall average and maximum individual temperatures on west and east main trusses.....	76
Figure 5–41. Assembly No. 3 – average and maximum individual temperatures on south bridging truss.....	77
Figure 5–42. Assembly No. 3 – average and maximum individual temperatures on north bridging truss.....	77
Figure 5–43. Assembly No. 3 – average and maximum individual temperatures on unexposed surface.....	78
Figure 5–44. Assembly No. 3 – average temperatures on steel deck.....	78
Figure 5–45. Assembly No. 3 – bottom chord deflection measurements.....	79
Figure 5–46. Assembly No. 3 – temperatures of bottom chord deflection rods.....	79
Figure 5–47. Assembly No. 3 – unexposed surface deflection measurements.....	80
Figure 5–48. Assembly No. 3 – additional instrumentation through south opening.....	80
Figure 5–49. Assembly No. 3 – additional instrumentation through north opening.....	81
Figure 5–50. Unexposed surface of Assembly No. 3 after loading equipment was removed.....	81
Figure 5–51. Detail of spalling concrete at north end of Assembly No. 3.....	82
Figure 5–52. View of column-end diagonal strut of west main truss on Assembly No. 3.....	82
Figure 5–53. Intersection of north bridging and west main truss on Assembly 3.....	83
Figure 5–54. Assembly No. 4 – average and maximum individual temperatures on west main truss.....	85

Figure 5–55.	Assembly No. 4 – average and maximum individual temperatures on east main truss.....	86
Figure 5–56.	Assembly No. 4 – overall average and maximum individual temperatures on west and east main trusses.....	86
Figure 5–57.	Assembly No. 4 – average and maximum individual temperatures on south bridging truss.....	87
Figure 5–58.	Assembly No. 4 – average and maximum individual temperatures on south bridging truss.....	87
Figure 5–59.	Assembly No. 4 – average and maximum individual temperatures on unexposed surface.....	88
Figure 5–60.	Assembly No. 4 – average temperatures on steel deck.....	88
Figure 5–61.	Assembly No. 4 – bottom chord deflection measurements.....	89
Figure 5–62.	Assembly No. 4 – temperatures of bottom chord deflection rods.....	89
Figure 5–63.	Assembly No. 4 – unexposed surface deflection measurements.....	90
Figure 5–64.	Assembly No. 4 – additional instrumentation through south opening.....	90
Figure 5–65.	Assembly No. 4 – additional instrumentation through south opening.....	91
Figure 5–66.	Unexposed surface of Assembly No. 4 after loading equipment was removed.....	91
Figure 5–67.	Unexposed surface of Assembly No. 4, view of concrete spalling on west side of assembly.....	92
Figure 5–68.	Unexposed surface of Assembly No. 4, close-up of concrete spalling on west side of assembly.....	92
Figure 5–69.	Intersection of north bridging and west main truss on Assembly 4.....	93
Figure 5–70.	View looking north of south bridging truss at location where concrete spalling occurred on Assembly 4.....	93
Figure 6–1.	Comparison of average furnace temperatures.....	97
Figure 6–2.	Temperatures measured at the bottom chord by the plate thermocouple in the ULC furnace (Test No. 2) and ULN furnace (Test No. 4).....	98
Figure 6–3.	Temperatures measured at the underside of the metal deck by the plate thermocouple at the ULC furnace (Test No. 2) and ULN furnace (Test No. 4).....	99
Figure 6–4.	Average temperatures of the bottom chord for Test Nos. 1, 2 and 3 (3/4 in. thick SFRM).....	100
Figure 6–5.	Average temperature of web diagonals for Test Nos. 1, 2 and 3 (3/4 in. thick SFRM).....	101
Figure 6–6.	Average temperature of the top chord for Test Nos. 1, 2 and 3 (3/4 in. thick SFRM).....	102
Figure 6–7.	Average temperature of the bottom chord for Test No. 3 (3/4 in. thick SFRM) and No. 4 (1/2 in. thick SFRM).....	103
Figure 6–8.	Average temperature of the unexposed surface for all four tests.....	104
Figure 6–9.	Deflection measured at the center of each assembly.....	105
Figure 6–10.	Deflection measured at the center of each assembly divided by the span.....	105

LIST OF TABLES

Table P-1.	Federal building and fire safety investigation of the WTC disaster.....	xviii
Table P-2.	Public meetings and briefings of the WTC Investigation.	xxi
Table 4-1.	Redistance Weld Data.....	13
Table 4-2.	Concrete mix design per cubic yard of concrete.....	21
Table 4-3.	General construction details.....	22
Table 4-4.	Details of concrete placement.....	30
Table 4-5.	SFRM Thickness measurements on Assembly No. 1.....	33
Table 4-6.	Air dry density of spray applied fire resistive material on Assembly No. 1.....	33
Table 4-7.	Thickness measurements on Assembly No. 2.....	35
Table 4-8.	Air dry density of spray applied fire resistive material on Assembly No. 2.....	35
Table 4-9.	Details of concrete.	40
Table 4-10.	SFRM Thickness measurements on Assembly No. 3.....	42
Table 4-11.	Air dry density of spray applied fire resistive material on Assembly No. 3.....	42
Table 4-12.	Thickness measurements on Assembly No. 4.....	42
Table 4-13.	Air dry density of spray applied fire resistive material on Assembly No. 4.....	42
Table 4-14.	Summary of analysis for maximum load condition for 35 ft assembly.....	44
Table 4-15.	Summary of analysis for maximum load condition for 17 ft assembly.....	45
Table 4-16.	Summary of radiometers.....	47
Table 5-1.	Test observations – Assembly 1.....	49
Table 5-2.	Test observations – Assembly No. 2.....	63
Table 5-3.	Test observations – Assembly No. 3.....	74
Table 5-4.	Test observations – Assembly No. 4.....	84
Table 5-5.	Times to reach ASTM E 119 end-point criteria and ASTM E 119 hourly ratings.....	96

This page intentionally left blank.

LIST OF ACRONYMS AND ABBREVIATIONS

Acronyms

ASTM	American Society for Testing and Materials, ASTM International
CMTR	Certified Mill Test Report
MIG	Metal Inert Gas (welding)
NIST	National Institute of Standards and Technology
PANYNJ	Port Authority of New York and New Jersey
SFRM	sprayed fire-resistive material
STS	STS Consultants, Ltd.
SMAW	shielded metal arc welding
ULC	Underwriters Laboratories of Canada, Toronto, Ontario, Fire Test Facility
ULN	Underwriters Laboratories, Inc., Northbrook, Illinois, Fire Test Facility
UL	Underwriters Laboratories Inc.
USM	United States Minerals Products, Co.
WJE	Wiss Janey Elstner & Associates
WTC	World Trade Center
WWF	welded wire fabric

Abbreviations

°C	degrees Celsius (centigrade)
°F	degrees Fahrenheit
ft	feet
in.	inch
lb	pound (force)
min	minute
o.c.	on center
pcf	pounds per cubic foot (1 pcf = 16.03 kg/m ³)
psf	pounds per square foot (1 psf = 0.0479 kN/m ²)
psi	pounds per square inch (1 psi = 0.006895 N/mm ² or 0.006895 MPa)
s	second

This page intentionally left blank.

PREFACE

Genesis of This Investigation

Immediately following the terrorist attack on the World Trade Center (WTC) on September 11, 2001, the Federal Emergency Management Agency (FEMA) and the American Society of Civil Engineers began planning a building performance study of the disaster. The week of October 7, as soon as the rescue and search efforts ceased, the Building Performance Study Team went to the site and began its assessment. This was to be a brief effort, as the study team consisted of experts who largely volunteered their time away from their other professional commitments. The Building Performance Study Team issued its report in May 2002, fulfilling its goal “to determine probable failure mechanisms and to identify areas of future investigation that could lead to practical measures for improving the damage resistance of buildings against such unforeseen events.”

On August 21, 2002, with funding from the U.S. Congress through FEMA, the National Institute of Standards and Technology (NIST) announced its building and fire safety investigation of the WTC disaster. On October 1, 2002, the National Construction Safety Team Act (Public Law 107-231), was signed into law. The NIST WTC Investigation was conducted under the authority of the National Construction Safety Team Act.

The goals of the investigation of the WTC disaster were:

- To investigate the building construction, the materials used, and the technical conditions that contributed to the outcome of the WTC disaster.
- To serve as the basis for:
 - Improvements in the way buildings are designed, constructed, maintained, and used;
 - Improved tools and guidance for industry and safety officials;
 - Recommended revisions to current codes, standards, and practices; and
 - Improved public safety.

The specific objectives were:

1. Determine why and how WTC 1 and WTC 2 collapsed following the initial impacts of the aircraft and why and how WTC 7 collapsed;
2. Determine why the injuries and fatalities were so high or low depending on location, including all technical aspects of fire protection, occupant behavior, evacuation, and emergency response;
3. Determine what procedures and practices were used in the design, construction, operation, and maintenance of WTC 1, 2, and 7; and
4. Identify, as specifically as possible, areas in current building and fire codes, standards, and practices that warrant revision.

NIST is a nonregulatory agency of the U.S. Department of Commerce’s Technology Administration. The purpose of NIST investigations is to improve the safety and structural integrity of buildings in the United States, and the focus is on fact finding. NIST investigative teams are authorized to assess building performance and emergency response and evacuation procedures in the wake of any building failure that has resulted in substantial loss of life or that posed significant potential of substantial loss of life. NIST does not have the statutory authority to make findings of fault nor negligence by individuals or organizations. Further, no part of any report resulting from a NIST investigation into a building failure or from an investigation under the National Construction Safety Team Act may be used in any suit or action for damages arising out of any matter mentioned in such report (15 USC 281a, as amended by Public Law 107-231).

Organization of the Investigation

The National Construction Safety Team for this Investigation, appointed by the then NIST Director, Dr. Arden L. Bement, Jr., was led by Dr. S. Shyam Sunder. Dr. William L. Grosshandler served as Associate Lead Investigator, Mr. Stephen A. Cauffman served as Program Manager for Administration, and Mr. Harold E. Nelson served on the team as a private sector expert. The Investigation included eight interdependent projects whose leaders comprised the remainder of the team. A detailed description of each of these eight projects is available at <http://wtc.nist.gov>. The purpose of each project is summarized in Table P–1, and the key interdependencies among the projects are illustrated in Fig. P–1.

Table P–1. Federal building and fire safety investigation of the WTC disaster.

Technical Area and Project Leader	Project Purpose
Analysis of Building and Fire Codes and Practices; Project Leaders: Dr. H. S. Lew and Mr. Richard W. Bukowski	Document and analyze the code provisions, procedures, and practices used in the design, construction, operation, and maintenance of the structural, passive fire protection, and emergency access and evacuation systems of WTC 1, 2, and 7.
Baseline Structural Performance and Aircraft Impact Damage Analysis; Project Leader: Dr. Fahim H. Sadek	Analyze the baseline performance of WTC 1 and WTC 2 under design, service, and abnormal loads, and aircraft impact damage on the structural, fire protection, and egress systems.
Mechanical and Metallurgical Analysis of Structural Steel; Project Leader: Dr. Frank W. Gayle	Determine and analyze the mechanical and metallurgical properties and quality of steel, weldments, and connections from steel recovered from WTC 1, 2, and 7.
Investigation of Active Fire Protection Systems; Project Leader: Dr. David D. Evans; Dr. William Grosshandler	Investigate the performance of the active fire protection systems in WTC 1, 2, and 7 and their role in fire control, emergency response, and fate of occupants and responders.
Reconstruction of Thermal and Tenability Environment; Project Leader: Dr. Richard G. Gann	Reconstruct the time-evolving temperature, thermal environment, and smoke movement in WTC 1, 2, and 7 for use in evaluating the structural performance of the buildings and behavior and fate of occupants and responders.
Structural Fire Response and Collapse Analysis; Project Leaders: Dr. John L. Gross and Dr. Therese P. McAllister	Analyze the response of the WTC towers to fires with and without aircraft damage, the response of WTC 7 in fires, the performance of composite steel-trussed floor systems, and determine the most probable structural collapse sequence for WTC 1, 2, and 7.
Occupant Behavior, Egress, and Emergency Communications; Project Leader: Mr. Jason D. Averill	Analyze the behavior and fate of occupants and responders, both those who survived and those who did not, and the performance of the evacuation system.
Emergency Response Technologies and Guidelines; Project Leader: Mr. J. Randall Lawson	Document the activities of the emergency responders from the time of the terrorist attacks on WTC 1 and WTC 2 until the collapse of WTC 7, including practices followed and technologies used.

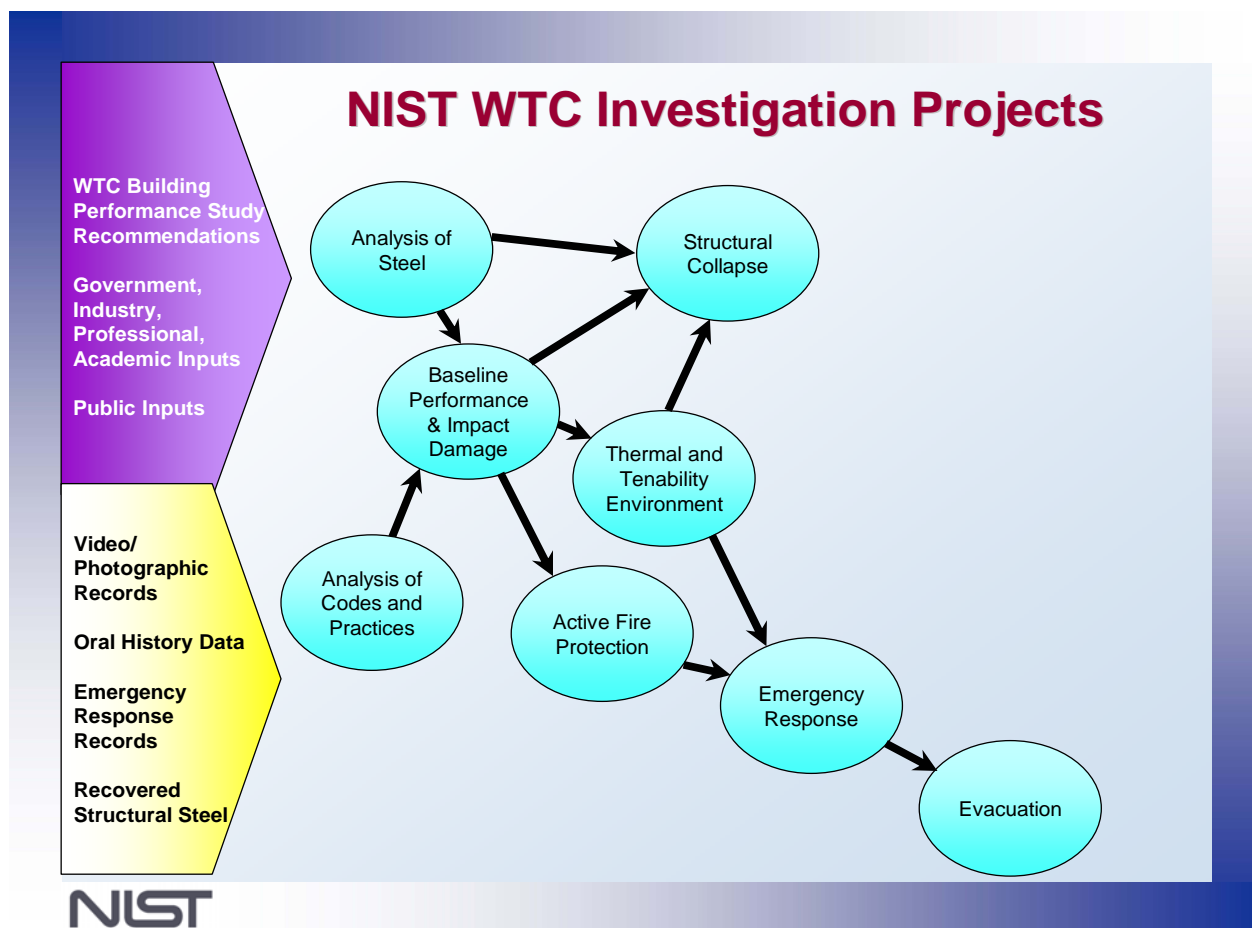

Figure P-1. The eight projects in the federal building and fire safety investigation of the WTC disaster.

National Construction Safety Team Advisory Committee

The NIST Director also established an advisory committee as mandated under the National Construction Safety Team Act. The initial members of the committee were appointed following a public solicitation. These were:

- Paul Fitzgerald, Executive Vice President (retired) FM Global, National Construction Safety Team Advisory Committee Chair
- John Barsom, President, Barsom Consulting, Ltd.
- John Bryan, Professor Emeritus, University of Maryland
- David Collins, President, The Preview Group, Inc.
- Glenn Corbett, Professor, John Jay College of Criminal Justice
- Philip DiNunno, President, Hughes Associates, Inc.

- Robert Hanson, Professor Emeritus, University of Michigan
- Charles Thornton, Co-Chairman and Managing Principal, The Thornton-Tomasetti Group, Inc.
- Kathleen Tierney, Director, Natural Hazards Research and Applications Information Center, University of Colorado at Boulder
- Forman Williams, Director, Center for Energy Research, University of California at San Diego

This National Construction Safety Team Advisory Committee provided technical advice during the Investigation and commentary on drafts of the Investigation reports prior to their public release. NIST has benefited from the work of many people in the preparation of these reports, including the National Construction Safety Team Advisory Committee. The content of the reports and recommendations, however, are solely the responsibility of NIST.

Public Outreach

During the course of this Investigation, NIST held public briefings and meetings (listed in Table P-2) to solicit input from the public, present preliminary findings, and obtain comments on the direction and progress of the Investigation from the public and the Advisory Committee.

NIST maintained a publicly accessible Web site during this Investigation at <http://wtc.nist.gov>. The site contained extensive information on the background and progress of the Investigation.

NIST's WTC Public-Private Response Plan

The collapse of the WTC buildings has led to broad reexamination of how tall buildings are designed, constructed, maintained, and used, especially with regard to major events such as fires, natural disasters, and terrorist attacks. Reflecting the enhanced interest in effecting necessary change, NIST, with support from Congress and the Administration, has put in place a program, the goal of which is to develop and implement the standards, technology, and practices needed for cost-effective improvements to the safety and security of buildings and building occupants, including evacuation, emergency response procedures, and threat mitigation.

The strategy to meet this goal is a three-part NIST-led public-private response program that includes:

- A federal building and fire safety investigation to study the most probable factors that contributed to post-aircraft impact collapse of the WTC towers and the 47-story WTC 7 building, and the associated evacuation and emergency response experience.
- A research and development (R&D) program to (a) facilitate the implementation of recommendations resulting from the WTC Investigation, and (b) provide the technical basis for cost-effective improvements to national building and fire codes, standards, and practices that enhance the safety of buildings, their occupants, and emergency responders.

Table P–2. Public meetings and briefings of the WTC Investigation.

Date	Location	Principal Agenda
June 24, 2002	New York City, NY	Public meeting: Public comments on the <i>Draft Plan</i> for the pending WTC Investigation.
August 21, 2002	Gaithersburg, MD	Media briefing announcing the formal start of the Investigation.
December 9, 2002	Washington, DC	Media briefing on release of the <i>Public Update</i> and NIST request for photographs and videos.
April 8, 2003	New York City, NY	Joint public forum with Columbia University on first-person interviews.
April 29–30, 2003	Gaithersburg, MD	NCST Advisory Committee meeting on plan for and progress on WTC Investigation with a public comment session.
May 7, 2003	New York City, NY	Media briefing on release of <i>May 2003 Progress Report</i> .
August 26–27, 2003	Gaithersburg, MD	NCST Advisory Committee meeting on status of the WTC investigation with a public comment session.
September 17, 2003	New York City, NY	Media and public briefing on initiation of first-person data collection projects.
December 2–3, 2003	Gaithersburg, MD	NCST Advisory Committee meeting on status and initial results and release of the <i>Public Update</i> with a public comment session.
February 12, 2004	New York City, NY	Public meeting on progress and preliminary findings with public comments on issues to be considered in formulating final recommendations.
June 18, 2004	New York City, NY	Media/public briefing on release of <i>June 2004 Progress Report</i> .
June 22–23, 2004	Gaithersburg, MD	NCST Advisory Committee meeting on the status of and preliminary findings from the WTC Investigation with a public comment session.
August 24, 2004	Northbrook, IL	Public viewing of standard fire resistance test of WTC floor system at Underwriters Laboratories, Inc.
October 19–20, 2004	Gaithersburg, MD	NCST Advisory Committee meeting on status and near complete set of preliminary findings with a public comment session.
November 22, 2004	Gaithersburg, MD	NCST Advisory Committee discussion on draft annual report to Congress, a public comment session, and a closed session to discuss pre-draft recommendations for WTC Investigation.
April 5, 2005	New York City, NY	Media and public briefing on release of the probable collapse sequence for the WTC towers and draft reports for the projects on codes and practices, evacuation, and emergency response.
June 23, 2005	New York City, NY	Media and public briefing on release of all draft reports for the WTC towers and draft recommendations for public comment.
September 12–13, 2005	Gaithersburg, MD	NCST Advisory Committee meeting on disposition of public comments and update to draft reports for the WTC towers.
September 13–15, 2005	Gaithersburg, MD	WTC Technical Conference for stakeholders and technical community for dissemination of findings and recommendations and opportunity for public to make technical comments.

- A dissemination and technical assistance program (DTAP) to (a) engage leaders of the construction and building community in ensuring timely adoption and widespread use of proposed changes to practices, standards, and codes resulting from the WTC Investigation and the R&D program, and (b) provide practical guidance and tools to better prepare facility owners, contractors, architects, engineers, emergency responders, and regulatory authorities to respond to future disasters.

The desired outcomes are to make buildings, occupants, and first responders safer in future disaster events.

National Construction Safety Team Reports on the WTC Investigation

A final report on the collapse of the WTC towers is being issued as NIST NCSTAR 1. A companion report on the collapse of WTC 7 is being issued as NIST NCSTAR 1A. The present report is one of a set that provides more detailed documentation of the Investigation findings and the means by which these technical results were achieved. As such, it is part of the archival record of this Investigation. The titles of the full set of Investigation publications are:

NIST (National Institute of Standards and Technology). 2005. *Federal Building and Fire Safety Investigation of the World Trade Center Disaster: Final Report on the Collapse of the World Trade Center Towers*. NIST NCSTAR 1. Gaithersburg, MD, September.

NIST (National Institute of Standards and Technology). 2006. *Federal Building and Fire Safety Investigation of the World Trade Center Disaster: Final Report on the Collapse of World Trade Center 7*. NIST NCSTAR 1A. Gaithersburg, MD.

Lew, H. S., R. W. Bukowski, and N. J. Carino. 2005. *Federal Building and Fire Safety Investigation of the World Trade Center Disaster: Design, Construction, and Maintenance of Structural and Life Safety Systems*. NIST NCSTAR 1-1. National Institute of Standards and Technology. Gaithersburg, MD, September.

Fanella, D. A., A. T. Derecho, and S. K. Ghosh. 2005. *Federal Building and Fire Safety Investigation of the World Trade Center Disaster: Design and Construction of Structural Systems*. NIST NCSTAR 1-1A. National Institute of Standards and Technology. Gaithersburg, MD, September.

Ghosh, S. K., and X. Liang. 2005. *Federal Building and Fire Safety Investigation of the World Trade Center Disaster: Comparison of Building Code Structural Requirements*. NIST NCSTAR 1-1B. National Institute of Standards and Technology. Gaithersburg, MD, September.

Fanella, D. A., A. T. Derecho, and S. K. Ghosh. 2005. *Federal Building and Fire Safety Investigation of the World Trade Center Disaster: Maintenance and Modifications to Structural Systems*. NIST NCSTAR 1-1C. National Institute of Standards and Technology. Gaithersburg, MD, September.

Grill, R. A., and D. A. Johnson. 2005. *Federal Building and Fire Safety Investigation of the World Trade Center Disaster: Fire Protection and Life Safety Provisions Applied to the Design and Construction of World Trade Center 1, 2, and 7 and Post-Construction Provisions Applied after Occupancy*. NIST NCSTAR 1-1D. National Institute of Standards and Technology. Gaithersburg, MD, September.

Razza, J. C., and R. A. Grill. 2005. *Federal Building and Fire Safety Investigation of the World Trade Center Disaster: Comparison of Codes, Standards, and Practices in Use at the Time of the Design and Construction of World Trade Center 1, 2, and 7*. NIST NCSTAR 1-1E. National Institute of Standards and Technology. Gaithersburg, MD, September.

Grill, R. A., D. A. Johnson, and D. A. Fanella. 2005. *Federal Building and Fire Safety Investigation of the World Trade Center Disaster: Comparison of the 1968 and Current (2003) New*

- York City Building Code Provisions*. NIST NCSTAR 1-1F. National Institute of Standards and Technology. Gaithersburg, MD, September.
- Grill, R. A., and D. A. Johnson. 2005. *Federal Building and Fire Safety Investigation of the World Trade Center Disaster: Amendments to the Fire Protection and Life Safety Provisions of the New York City Building Code by Local Laws Adopted While World Trade Center 1, 2, and 7 Were in Use*. NIST NCSTAR 1-1G. National Institute of Standards and Technology. Gaithersburg, MD, September.
- Grill, R. A., and D. A. Johnson. 2005. *Federal Building and Fire Safety Investigation of the World Trade Center Disaster: Post-Construction Modifications to Fire Protection and Life Safety Systems of World Trade Center 1 and 2*. NIST NCSTAR 1-1H. National Institute of Standards and Technology. Gaithersburg, MD, September.
- Grill, R. A., D. A. Johnson, and D. A. Fanella. 2005. *Federal Building and Fire Safety Investigation of the World Trade Center Disaster: Post-Construction Modifications to Fire Protection, Life Safety, and Structural Systems of World Trade Center 7*. NIST NCSTAR 1-1I. National Institute of Standards and Technology. Gaithersburg, MD, September.
- Grill, R. A., and D. A. Johnson. 2005. *Federal Building and Fire Safety Investigation of the World Trade Center Disaster: Design, Installation, and Operation of Fuel System for Emergency Power in World Trade Center 7*. NIST NCSTAR 1-1J. National Institute of Standards and Technology. Gaithersburg, MD, September.
- Sadek, F. 2005. *Federal Building and Fire Safety Investigation of the World Trade Center Disaster: Baseline Structural Performance and Aircraft Impact Damage Analysis of the World Trade Center Towers*. NIST NCSTAR 1-2. National Institute of Standards and Technology. Gaithersburg, MD, September.
- Faschan, W. J., and R. B. Garlock. 2005. *Federal Building and Fire Safety Investigation of the World Trade Center Disaster: Reference Structural Models and Baseline Performance Analysis of the World Trade Center Towers*. NIST NCSTAR 1-2A. National Institute of Standards and Technology. Gaithersburg, MD, September.
- Kirkpatrick, S. W., R. T. Bocchieri, F. Sadek, R. A. MacNeill, S. Holmes, B. D. Peterson, R. W. Cilke, C. Navarro. 2005. *Federal Building and Fire Safety Investigation of the World Trade Center Disaster: Analysis of Aircraft Impacts into the World Trade Center Towers*, NIST NCSTAR 1-2B. National Institute of Standards and Technology. Gaithersburg, MD, September.
- Gayle, F. W., R. J. Fields, W. E. Luecke, S. W. Banovic, T. Foecke, C. N. McCowan, T. A. Siewert, and J. D. McColskey. 2005. *Federal Building and Fire Safety Investigation of the World Trade Center Disaster: Mechanical and Metallurgical Analysis of Structural Steel*. NIST NCSTAR 1-3. National Institute of Standards and Technology. Gaithersburg, MD, September.
- Luecke, W. E., T. A. Siewert, and F. W. Gayle. 2005. *Federal Building and Fire Safety Investigation of the World Trade Center Disaster: Contemporaneous Structural Steel Specifications*. NIST Special Publication 1-3A. National Institute of Standards and Technology. Gaithersburg, MD, September.

Banovic, S. W. 2005. *Federal Building and Fire Safety Investigation of the World Trade Center Disaster: Steel Inventory and Identification*. NIST NCSTAR 1-3B. National Institute of Standards and Technology. Gaithersburg, MD, September.

Banovic, S. W., and T. Foecke. 2005. *Federal Building and Fire Safety Investigation of the World Trade Center Disaster: Damage and Failure Modes of Structural Steel Components*. NIST NCSTAR 1-3C. National Institute of Standards and Technology. Gaithersburg, MD, September.

Luecke, W. E., J. D. McColskey, C. N. McCowan, S. W. Banovic, R. J. Fields, T. Foecke, T. A. Siewert, and F. W. Gayle. 2005. *Federal Building and Fire Safety Investigation of the World Trade Center Disaster: Mechanical Properties of Structural Steels*. NIST NCSTAR 1-3D. National Institute of Standards and Technology. Gaithersburg, MD, September.

Banovic, S. W., C. N. McCowan, and W. E. Luecke. 2005. *Federal Building and Fire Safety Investigation of the World Trade Center Disaster: Physical Properties of Structural Steels*. NIST NCSTAR 1-3E. National Institute of Standards and Technology. Gaithersburg, MD, September.

Evans, D. D., R. D. Peacock, E. D. Kuligowski, W. S. Dols, and W. L. Grosshandler. 2005. *Federal Building and Fire Safety Investigation of the World Trade Center Disaster: Active Fire Protection Systems*. NIST NCSTAR 1-4. National Institute of Standards and Technology. Gaithersburg, MD, September.

Kuligowski, E. D., D. D. Evans, and R. D. Peacock. 2005. *Federal Building and Fire Safety Investigation of the World Trade Center Disaster: Post-Construction Fires Prior to September 11, 2001*. NIST NCSTAR 1-4A. National Institute of Standards and Technology. Gaithersburg, MD, September.

Hopkins, M., J. Schoenrock, and E. Budnick. 2005. *Federal Building and Fire Safety Investigation of the World Trade Center Disaster: Fire Suppression Systems*. NIST NCSTAR 1-4B. National Institute of Standards and Technology. Gaithersburg, MD, September.

Keough, R. J., and R. A. Grill. 2005. *Federal Building and Fire Safety Investigation of the World Trade Center Disaster: Fire Alarm Systems*. NIST NCSTAR 1-4C. National Institute of Standards and Technology. Gaithersburg, MD, September.

Ferreira, M. J., and S. M. Strege. 2005. *Federal Building and Fire Safety Investigation of the World Trade Center Disaster: Smoke Management Systems*. NIST NCSTAR 1-4D. National Institute of Standards and Technology. Gaithersburg, MD, September.

Gann, R. G., A. Hamins, K. B. McGrattan, G. W. Mulholland, H. E. Nelson, T. J. Ohlemiller, W. M. Pitts, and K. R. Prasad. 2005. *Federal Building and Fire Safety Investigation of the World Trade Center Disaster: Reconstruction of the Fires in the World Trade Center Towers*. NIST NCSTAR 1-5. National Institute of Standards and Technology. Gaithersburg, MD, September.

Pitts, W. M., K. M. Butler, and V. Junker. 2005. *Federal Building and Fire Safety Investigation of the World Trade Center Disaster: Visual Evidence, Damage Estimates, and Timeline Analysis*. NIST NCSTAR 1-5A. National Institute of Standards and Technology. Gaithersburg, MD, September.

- Hamins, A., A. Maranghides, K. B. McGrattan, E. Johnsson, T. J. Ohlemiller, M. Donnelly, J. Yang, G. Mulholland, K. R. Prasad, S. Kukuck, R. Anleitner and T. McAllister. 2005. *Federal Building and Fire Safety Investigation of the World Trade Center Disaster: Experiments and Modeling of Structural Steel Elements Exposed to Fire*. NIST NCSTAR 1-5B. National Institute of Standards and Technology. Gaithersburg, MD, September.
- Ohlemiller, T. J., G. W. Mulholland, A. Maranghides, J. J. Filliben, and R. G. Gann. 2005. *Federal Building and Fire Safety Investigation of the World Trade Center Disaster: Fire Tests of Single Office Workstations*. NIST NCSTAR 1-5C. National Institute of Standards and Technology. Gaithersburg, MD, September.
- Gann, R. G., M. A. Riley, J. M. Repp, A. S. Whittaker, A. M. Reinhorn, and P. A. Hough. 2005. *Federal Building and Fire Safety Investigation of the World Trade Center Disaster: Reaction of Ceiling Tile Systems to Shocks*. NIST NCSTAR 1-5D. National Institute of Standards and Technology. Gaithersburg, MD, September.
- Hamins, A., A. Maranghides, K. B. McGrattan, T. J. Ohlemiller, and R. Anleitner. 2005. *Federal Building and Fire Safety Investigation of the World Trade Center Disaster: Experiments and Modeling of Multiple Workstations Burning in a Compartment*. NIST NCSTAR 1-5E. National Institute of Standards and Technology. Gaithersburg, MD, September.
- McGrattan, K. B., C. Bouldin, and G. Forney. 2005. *Federal Building and Fire Safety Investigation of the World Trade Center Disaster: Computer Simulation of the Fires in the World Trade Center Towers*. NIST NCSTAR 1-5F. National Institute of Standards and Technology. Gaithersburg, MD, September.
- Prasad, K. R., and H. R. Baum. 2005. *Federal Building and Fire Safety Investigation of the World Trade Center Disaster: Fire Structure Interface and Thermal Response of the World Trade Center Towers*. NIST NCSTAR 1-5G. National Institute of Standards and Technology. Gaithersburg, MD, September.
- Gross, J. L., and T. McAllister. 2005. *Federal Building and Fire Safety Investigation of the World Trade Center Disaster: Structural Fire Response and Probable Collapse Sequence of the World Trade Center Towers*. NIST NCSTAR 1-6. National Institute of Standards and Technology. Gaithersburg, MD, September.
- Carino, N. J., M. A. Starnes, J. L. Gross, J. C. Yang, S. Kukuck, K. R. Prasad, and R. W. Bukowski. 2005. *Federal Building and Fire Safety Investigation of the World Trade Center Disaster: Passive Fire Protection*. NIST NCSTAR 1-6A. National Institute of Standards and Technology. Gaithersburg, MD, September.
- Gross, J., F. Hervey, M. Izydorek, J. Mammoser, and J. Treadway. 2005. *Federal Building and Fire Safety Investigation of the World Trade Center Disaster: Fire Resistance Tests of Floor Truss Systems*. NIST NCSTAR 1-6B. National Institute of Standards and Technology. Gaithersburg, MD, September.
- Zarghamee, M. S., S. Bolourchi, D. W. Eggers, Ö. O. Erbay, F. W. Kan, Y. Kitane, A. A. Liepins, M. Mudlock, W. I. Naguib, R. P. Ojdrovic, A. T. Sarawit, P. R. Barrett, J. L. Gross, and

T. P. McAllister. 2005. *Federal Building and Fire Safety Investigation of the World Trade Center Disaster: Component, Connection, and Subsystem Structural Analysis*. NIST NCSTAR 1-6C. National Institute of Standards and Technology. Gaithersburg, MD, September.

Zarghamee, M. S., Y. Kitane, Ö. O. Erbay, T. P. McAllister, and J. L. Gross. 2005. *Federal Building and Fire Safety Investigation of the World Trade Center Disaster: Global Structural Analysis of the Response of the World Trade Center Towers to Impact Damage and Fire*. NIST NCSTAR 1-6D. National Institute of Standards and Technology. Gaithersburg, MD, September.

McAllister, T., R. W. Bukowski, R. G. Gann, J. L. Gross, K. B. McGrattan, H. E. Nelson, L. Phan, W. M. Pitts, K. R. Prasad, F. Sadek. 2006. *Federal Building and Fire Safety Investigation of the World Trade Center Disaster: Structural Fire Response and Probable Collapse Sequence of World Trade Center 7*. (Provisional). NIST NCSTAR 1-6E. National Institute of Standards and Technology. Gaithersburg, MD.

Gilsanz, R., V. Arbitrio, C. Anders, D. Chlebus, K. Ezzeldin, W. Guo, P. Moloney, A. Montalva, J. Oh, K. Rubenacker. 2006. *Federal Building and Fire Safety Investigation of the World Trade Center Disaster: Structural Analysis of the Response of World Trade Center 7 to Debris Damage and Fire*. (Provisional). NIST NCSTAR 1-6F. National Institute of Standards and Technology. Gaithersburg, MD.

Kim, W. 2006. *Federal Building and Fire Safety Investigation of the World Trade Center Disaster: Analysis of September 11, 2001, Seismogram Data*. (Provisional). NIST NCSTAR 1-6G. National Institute of Standards and Technology. Gaithersburg, MD.

Nelson, K. 2006. *Federal Building and Fire Safety Investigation of the World Trade Center Disaster: The Con Ed Substation in World Trade Center 7*. (Provisional). NIST NCSTAR 1-6H. National Institute of Standards and Technology. Gaithersburg, MD.

Averill, J. D., D. S. Mileti, R. D. Peacock, E. D. Kuligowski, N. Groner, G. Proulx, P. A. Reneke, and H. E. Nelson. 2005. *Federal Building and Fire Safety Investigation of the World Trade Center Disaster: Occupant Behavior, Egress, and Emergency Communication*. NIST NCSTAR 1-7. National Institute of Standards and Technology. Gaithersburg, MD, September.

Fahy, R., and G. Proulx. 2005. *Federal Building and Fire Safety Investigation of the World Trade Center Disaster: Analysis of Published Accounts of the World Trade Center Evacuation*. NIST NCSTAR 1-7A. National Institute of Standards and Technology. Gaithersburg, MD, September.

Zmud, J. 2005. *Federal Building and Fire Safety Investigation of the World Trade Center Disaster: Technical Documentation for Survey Administration*. NIST NCSTAR 1-7B. National Institute of Standards and Technology. Gaithersburg, MD, September.

Lawson, J. R., and R. L. Vettori. 2005. *Federal Building and Fire Safety Investigation of the World Trade Center Disaster: The Emergency Response Operations*. NIST NCSTAR 1-8. National Institute of Standards and Technology. Gaithersburg, MD, September.

ACKNOWLEDGMENTS

The National Institute of Standards and Technology would like to acknowledge the many individuals who contributed substantially to the successful completion of four ASTM E 119 Standard Fire Tests conducted by Underwriters Laboratories, Inc. (UL) under contract to NIST and reported herein. Specifically, the laboratory staff at UL including William Joy, Aldo Jimenez, and Romuald Bolewski did an outstanding and highly professional job. Colleagues at NIST who contributed both technically as well as administratively include Dr. Nicholas Carino, Dr. William Grosshandler, and Dr. Monica Starnes.

This page intentionally left blank.

EXECUTIVE SUMMARY

E.1 OBJECTIVES OF THE FIRE RESISTANCE TESTS

One of the objectives of the National Institute of Standards and Technology (NIST) Investigation was to determine why and how the World Trade Center (WTC) towers collapsed following the initial impact of the aircraft. A key aspect of this work was to differentiate the factors that most influenced the collapse of the WTC towers as they may relate to normal building and fire safety considerations and those unique to the terrorist attacks of September 11, 2001. Another of the NIST Investigation objectives was to study the procedures and practices that were used in the design, construction, operation, and maintenance of the WTC buildings. As an important public safety objective, it was necessary to establish the facts regarding the acceptance procedures for innovative materials, technologies, and systems. Past building and fire safety investigations have shown that such studies help to identify improvements to practices, standards, and codes that may be warranted.

NIST review of available documents had indicated that the fire performance of the composite floor system of the WTC towers was an issue of concern to the building owners and designers not only during the original design phase but throughout the service life of the buildings. NIST found no evidence regarding the technical basis for the selection of sprayed fire-resistive material (SFRM) for the WTC floor trusses and for the SFRM thickness to achieve a 2 h rating. Further, no evidence was found that fire resistance tests of the WTC floor system were conducted. Review of documents related to the WTC has not identified a similar concern for other structural components of the WTC towers.

To address, in part, the investigation objectives cited above, NIST conducted a series of four standard fire resistance tests of the composite floor system used in the towers. The fire resistance tests were conducted to study three factors: the effect of (1) SFRM thickness, (2) test restraint conditions, and (3) scale of the test. The tests were conducted by Underwriters Laboratories, Inc. (UL) under contract to NIST at UL's Northbrook (Illinois) fire testing facility and at its affiliate's, Underwriters Laboratories of Canada, fire testing facilities in Toronto.

E.2 THE WTC FLOOR SYSTEM AND SFRM

The floor system design for the world trade center consisted of a lightweight concrete floor slab supported by steel trusses bridging between the building's core columns and exterior wall columns. The main composite trusses, which were used in pairs, spanned either 60 ft or 35 ft. Steel double-angles formed the top and bottom chords of the trusses, while round bars were used for the webs. The web members protruded above the top chord in the form of a "knuckle" which was embedded in the concrete slab to develop composite action. Additionally, the floor system included bridging trusses perpendicular to the main trusses. In the corners of the towers, the bridging trusses acted with the main trusses to provide two-way slab action.

Passive fire protection was provided by sprayed fire-resistive materials (SFRM), commonly referred to as "fireproofing," applied directly to the steel bars of the trusses. The Port Authority of New York and New Jersey (PANYNJ or Port Authority) specified U.S. Minerals Products Cafco BLAZE-SHIELD Type D as

the sprayed fire-resistive material and in a letter to the fireproofing contractor stated that “All Tower beams, spandrels, and bar joists requiring spray-on fireproofing are to have a ½” [1/2 in] covering of Cafco¹”. Measured thicknesses of the applied SFRM were found to vary between 0.52 in. and 1.17 in. with an overall average of approximately 0.75 in. These two thicknesses, ½ in. representing specified thickness and ¾ in. representing average applied thickness, were used in the standard fire resistance tests described here.

E.3 FIRE RESISTANCE TESTING

The fire rating of structural materials and assemblies is generally determined through testing, and in the United States, such testing is frequently conducted in accordance with ASTM E 119, “Standard Test Methods for Fire Tests of Building Construction and Materials.” The test methods described in ASTM E 119 prescribe a standard fire exposure for comparing the test results of building construction assemblies. For the tests of floors and roofs, a test assembly is structurally loaded and the standard fire exposure is applied to the underside of the specimen. The assembly is evaluated for its ability to contain the fire by limiting flame spread (hot gasses) and heating of the unexposed surface while maintaining the applied load. The assembly is given a rating, expressed in hours, based on these conditions of acceptance.

Since 1971, versions of the ASTM E 119 Standard differentiate between testing and classifying thermally restrained and unrestrained floor assemblies. A thermally restrained specimen is “one in which expansion at the support of a load carrying element resulting from the effects of fire is resisted by forces external to the element.” In an unrestrained condition, the element is free to expand and rotate at its supports. It is customary in the United States to conduct standard fire tests of floor assemblies in the restrained condition.

The current standard describes a means to establish restrained and unrestrained ratings for floor assemblies from restrained test samples. For restrained ratings from restrained test samples, the conditions of acceptance are based on limiting the passage of flame and hot gasses, limiting temperatures on the unexposed surface of the slab, and failure of the assembly to sustain the applied load. For an unrestrained rating determined from a restrained test sample, the conditions of acceptance are based on the same criteria and, in addition, temperature limitations are placed on the main structural members.

In addition, since 1971, the ASTM E 119 Standard describes a means to establish unrestrained ratings from unrestrained test samples. For unrestrained samples, the fire resistance rating is again based on limiting passage of flame and hot gasses, exceeding temperatures on the unexposed surface of the slab, and failure to sustain the applied load; there are no limiting temperatures on the steel structural members when the test sample is installed in an unrestrained condition.

Prior to 1970, there was no distinction between restraint conditions, nor were restrained and unrestrained ratings defined in ASTM E 119. Fire resistance ratings were determined based upon the same requirements as for restrained assemblies described above, and no limitations were placed on temperature of structural steel.

¹ Cafco was the manufacturer of the SFRM used for fire protection of structural steel in the WTC.

In practice, a floor assembly such as that used in the WTC towers is neither restrained nor unrestrained but is likely somewhere in between. Testing under both restraint conditions, then, bounds expected performance under the standard fire exposure. In addition, it provides a comparison of unrestrained ratings developed from both restrained and unrestrained test conditions.

The ASTM E 119 Standard requires that, for floor and roof assembly tests, the area exposed to fire be a minimum of 180 ft² and neither dimension of the furnace less than 12 ft. Traditionally, relatively small scale assemblies have been tested, and results have been scaled to practical floor system spans.

The Underwriters Laboratories of Canada fire testing facility in Toronto, has a furnace with nominal dimensions of 35 ft by 14 ft. Thus, full- or large-scale tests of floor assemblies can be tested in this furnace. Availability of the 35 ft span furnace in UL's Toronto facility, in addition to the 17 ft span furnace its Northbrook, Illinois, facility allowed NIST to conduct tests to compare the effect of scale.

E.4 TEST PROGRAM

To limit the number of tests and obtain information of greatest value to meet the investigation objectives, NIST conducted four tests to study the effect of three factors: SFRM thickness, scale of the test, and test restraint conditions. To this end, four tests were designed and conducted as follows:

- Test #1: Full-scale, restrained test condition, $\frac{3}{4}$ in. thick SFRM.
- Test #2: Full-scale, unrestrained test condition, $\frac{3}{4}$ in. thick SFRM.
- Test #3: Reduced-scale, restrained conditions, $\frac{3}{4}$ in. thick SFRM.
- Test #4: Reduced-scale, restrained conditions, $\frac{1}{2}$ in. thick SFRM.

The full-scale tests were conducted at the Underwriters Laboratories of Canada fire testing facility in Toronto. Loading of the floor slab with an applied load to “simulate a maximum load condition,” as required by ASTM E 119, was accomplished through a combination concrete blocks and containers filled with water. The water containers were tied-off with steel cables to prevent them from falling into the furnace and causing damage to the fire brick and instrumentation in the event of a catastrophic failure of the floor system.

For the reduced-scale test specimens, the size of the truss members and thickness of concrete slab were selected to allow the most information to be extracted as practicably possible considering that the Standard Fire Resistance Test is a test of the assembly's ability to contain a fire and is based on both thermal response (flame spread and heating of the unexposed surface) and structural response (support the applied load) to the standard fire exposure. The sizes of the steel members, thickness of concrete slab, and truss spacing were selected to be the same as in the full-scale tests. Otherwise, the geometry was scaled by roughly half. This scaling required that the loading be increased by a factor of two.

E.5 TEST RESULTS

Results of the four tests are summarized as follows:

- The test assemblies were able to withstand standard fire conditions for between $\frac{3}{4}$ h and 2 h without exceeding the limits prescribed by ASTM E 119.
- Test specimens protected with $\frac{3}{4}$ in. thick spray applied fire-resistive material were able to sustain the maximum design load for approximately 2 hours without collapsing; in the unrestrained test, the load was maintained for $3\frac{1}{2}$ h without collapsing.
- The restrained full-scale floor system obtained a fire resistance rating of $1\frac{1}{2}$ h while the unrestrained floor system achieved a 2 h rating. Past experience with the ASTM E 119 test method would lead investigators to expect that the unrestrained floor assembly would not perform as well as the restrained assembly, and therefore, would receive a lower fire rating.
- A fire rating of 2 h was determined from the reduced-scale test with the average applied SFRM thickness of $\frac{3}{4}$ in., while a fire rating of $1\frac{1}{2}$ h was determined from the full-scale test with the same SFRM thickness.
- The result stated above raises the question of whether or not a fire rating based on the ASTM E 119 performance of a 17 ft span floor assembly is scalable to a larger floor system such as found in the WTC towers where spans ranged from 35 ft to 60 ft.
- A fire rating of $\frac{3}{4}$ h was determined from the reduced-scale test with the specified SFRM thickness of $\frac{1}{2}$ in.

The tested floor assemblies were similar, though not identical, to steel joist and concrete floor systems that are widely used in low rise construction. The test results provide valuable insight into the behavior of these widely used assemblies and also identify issues regarding scaling, restraint, and SFRM thickness that require further study for floor systems and other types of structural components such as beams, girders, columns, trusses, etc.

The NIST tests identified areas where further study related to the Standard Fire Resistance Test method may be warranted. The issues related to the test method that NIST will consider in formulating its recommendations include:

- the scale of the test for prototype assemblies that are much larger than the tested assemblies,
- the effect of restraint conditions on test results,
- the repeatability of test results (e.g., do multiple fire resistance tests conducted under the same conditions yield the same results?),
- the effects of test scale, end restraint, and test repeatability on other types of structural components (beams, girders, columns, etc.), and

- the acceptance criteria to evaluate the load carrying capacity of the tested assemblies (currently tests are stopped before the load carrying capacity of the assembly is reached because other acceptance criteria are met or because the deflection becomes excessive and assembly failure could damage the furnace).

This page intentionally left blank.

Chapter 1

INTRODUCTION

The need to perform fire resistance rating tests of the floor system developed for the World Trade Center (WTC) towers was raised several times during the design stage as well as after completion of the towers. National Institute of Standards and Technology (NIST) NCSTAR 1-6A² contains a detailed chronicle of the procedures and practices used for passive fire protection of the floor system of the WTC towers. The report summarizes factual data contained in documents provided to NIST by The Port Authority of New York and New Jersey (Port Authority) and its contractors and consultants; by Laclede Steel Company, the firm that supplied the floor trusses for the WTC towers; and by United States Mineral Products Co. (USM), the manufacturer of the SFRM. Review of the information collected revealed no evidence that testing was ever conducted to determine the fire endurance of the WTC floor system fireproofed with sprayed fire-resistive materials (SFRM).

1.1 MOTIVATION FOR CONDUCTING STANDARD FIRE TESTS OF THE WTC FLOOR SYSTEM

The first of the four NIST investigation objectives (*see Preface*) was to determine why and how the WTC towers collapsed following the initial impact of the aircraft. A key aspect of this work was to differentiate the factors that most influenced the collapse of the WTC towers as they may relate to normal building and fire safety considerations and those unique to the terrorist attacks of September 11, 2001.

Another of the four NIST investigation objectives was to study the procedures and practices that were used in the design, construction, operation, and maintenance of the WTC buildings. A key aspect was to study the acceptance procedures for innovative materials, technologies, and systems. Past building and fire safety investigations have shown that studies of procedures and practices help to identify improvements to practices, standards, and codes that may be warranted.

A third investigation objective was to identify, as specifically as possible, areas in national building and fire codes, standards, and practices that warrant revision.

NIST review of available documents related to the design and construction of the WTC towers indicated that the fire performance of the composite floor system of the WTC towers was an issue of concern to the building owners and designers from the original design and throughout the service life of the buildings (NIST NCSTAR 1-6A). NIST found no evidence to determine the technical basis for the selection of SFRM for the WTC floor trusses and of the thickness required to achieve a 2 hour rating. Further, NIST found no evidence that fire resistance tests of the WTC floor system were ever conducted. Review of the documents has not identified a similar concern for other structural components of the WTC towers.

² This reference is to one of the companion documents from this Investigation. A list of these documents appears in the Preface to this report.

1.2 PURPOSE OF THE STANDARD FIRE TESTS

To address these three investigation objectives, NIST conducted a series of four standard fire tests as described herein. The purpose of this series of tests was as follows:

- to establish the baseline performance of the floor system of the WTC towers as they were originally designed,
- to differentiate the factors that most influenced the collapse of the WTC towers as they may relate to normal building and fire safety considerations and those unique to the terrorist attacks of September 11, 2001,
- to determine whether there was an adequate technical basis for the original SFRM specification, and
- to study the procedures and practices used to accept an innovative structural and fire protection system.

1.3 TEST VARIABLES

To obtain information of greatest value to meet the investigation objectives, while limiting the number of tests to a practical number, NIST studied the effects of three factors: (1) SFRM thickness, (2) test restraint conditions, and (3) scale of the test. These factors are described more fully in this section.

1.3.1 SFRM Thickness

The Port Authority and its consultants sought an efficient and economical method to provide fire protection for the floor system and, by late 1965, the use of a fire-resistive material that was applied directly to the bars of the steel trusses was selected³. The Port Authority specified U.S. Minerals Products Cafco BLAZE-SHIELD Type D⁴ as the sprayed fire-resistive material and, in a letter to the fireproofing contractor stated,

“All Tower beams, spandrels, and bar joists requiring spray-on fireproofing are to have a ½” covering of Cafco.”⁵

Fire protection of a truss-supported floor system using a fire-resistive material applied directly to the steel trusses was innovative and not consistent with the practice at the time. Fire resistance testing of the floor assemblies constructed to represent as closely as practical those used in the WTC towers provides information to evaluate the procedures and practices used to accept an innovative system and to determine if there is a need for changes to those practices.

³ See NIST NCSRAT 1-6A for a detailed chronicle of the procedures and practices used for fire protection of structural steel in the WTC towers

⁴ This U.S. Minerals Products SFRM has been cited in WTC correspondence and documents using several designations. For consistency with other WTC Investigation reports, it is referred to herein as BLAZE-SHIELD D.

⁵ Letter dated October 30, 1969 from Robert J. Linn (Manager, Project Planning, The World Trade Center) to Mr. Louis DiBono (Mario & DiBono Plastering Co., Inc.).

The BLAZE-SHIELD D product originally specified contained asbestos and its use was discontinued in 1970 at the 38th floor of WTC 1. Thermal protection of the remaining floors of WTC 1 and all of WTC 2 was carried out using BLAZE-SHIELD DC/F, a product that contained mineral wool fibers in place of the asbestos fibers.

In 1994, the Port Authority performed a series of thickness measurements of the existing SFRM on floors 23 and 24 of WTC 1. Six measurements were taken from “both flanges and web” of each of 16 random trusses on each floor at those locations where the SFRM was not damaged or absent. Measured average thickness varied between 0.52 in. and 1.17 in. and for the 32 measurements (16 on each floor) the overall average was 0.74 in. Four of the 32 trusses, had an average thicknesses between 0.52 in. and 0.56 in. This limited set of data suggests that the average thickness of SFRM as originally installed (as contrasted with SFRM that was upgraded in thickness beginning in the 1990s) was approximately 0.75 in.

1.3.2 Restraint Conditions

It is customary in the United States to conduct standard fire tests of floor assemblies in the restrained condition; that is, the condition in which expansion at the support of the floor test assembly resulting from the effects of the exposing fire is resisted by forces external to the element. In practice, a floor assembly such as that used in the WTC towers is neither restrained nor unrestrained, but likely its restraint condition lies somewhere in between. Testing under both restraint conditions, then, provides bounds on the expected performance of the floor system under the standard fire exposure. In addition, it provides a comparison of unrestrained ratings developed from both restrained and unrestrained test conditions.

1.3.3 Scale

Traditionally, relatively light assemblies have been tested with spans less than 18 ft, and results have been scaled up to practical floor system dimensions and spans. The Underwriters Laboratories of Canada fire testing facility in Toronto (ULC) has a furnace with nominal long dimension of 35 ft. Thus, full- or large-scale tests of floor assemblies can be tested in this furnace. Availability of the 35 ft span furnace at ULC, in addition to the 17 ft span furnace at UL’s Northbrook, Illinois, facility (ULN) allowed NIST to conduct comparison tests to study the effect of scale⁶.

1.4 TEST PROGRAM

Four tests as noted above were designed and conducted as follows:

- Test No. 1: Full-scale, restrained test condition, $\frac{3}{4}$ in. thick SFRM.
- Test No. 2: Full-scale, unrestrained test condition, $\frac{3}{4}$ in. thick SFRM.
- Test No. 3: Reduced-scale, restrained conditions, $\frac{3}{4}$ in. thick SFRM.

⁶ ULC is used in this report to identify the fire testing facility operated by UL’s affiliate, Underwriters Laboratories of Canada, while ULN is used to identify UL’s Northbrook (Illinois) fire testing facility.

- Test No. 4: Reduced-scale, restrained conditions, ½ in. thick SFRM.

The objective of the full-scale restrained test with ¾ in. thick SFRM, Test 1, was to determine the baseline fire resistance of the floor system with average as-applied SFRM thickness. This test also demonstrated whether the fire resistance of such a system was significantly different from that of a system with the specified SFRM thickness of ½ in.

The test conditions for Test 2, full-scale unrestrained test with ¾ in. thick SFRM, were the same as those for Test 1 except that the specimen was supported to allow thermal expansion and, therefore, represented the unrestrained test condition. Results of this test allowed a determination of the unrestrained rating by test and, by comparing with the results of Test 1, a comparison of unrestrained ratings from both a restrained and unrestrained assembly test.

Test 3 was a reduced-scale test which, other than scale, was the same as Test 1. Thus, a comparison of the results of these two tests allowed an examination of whether test results are independent of test assembly scale.

Test assemblies for Tests 1, 2 and 3 were fire protected in the same manner, with ¾ in. thick SFRM representing the average SFRM thickness in the impact and fire affected floors of WTC 2. Measurements taken from photographs of the originally applied SFRM indicated that, while the SFRM thickness on main the trusses was approximately ¾ in., the thickness on the bridging trusses was approximately half that value (see NIST NCSTAR 1-6A). Also, photographs indicated that the metal deck was sometimes sprayed and sometimes not. For these three tests (Tests 1, 2, and 3), then, the main trusses were protected with ¾ in. thick SFRM, the bridging trusses with ¾ in. thick SFRM, and the metal deck was not intentionally sprayed but was also not masked from overspray and thereby had, in most instances, at least a light covering of SFRM. These conditions best represented the thickness of the SFRM as it was originally applied in the one-way slab areas.

The objective of the test with the ½ in. SFRM (Test 4) was to determine whether or not there was adequate technical basis for the original SFRM specification. As explained by the designer, it was not necessary to fire protect the bridging trusses in the one-way areas nor was it necessary to spray the metal deck (see NIST NCSTAR 1-6A). Consequently, the Test 4 specimen had ½ in. thick SFRM applied to the main trusses and no SFRM applied to either the bridging trusses or the underside of the metal deck. Both the bridging trusses and metal deck were masked to prevent overspray as well. These conditions best represented the SFRM that was necessary, in the opinion of the designer, to provide the required level of passive fire protection.

Chapter 2

ASTM STANDARD FIRE TEST

The fire rating of structural materials and assemblies is generally determined through testing, and in the United States, such testing is frequently conducted in accordance with the ASTM International standard, ASTM E 119, “Standard Test Methods for Fire Tests of Building Construction and Materials” (ASTM 2000). This standard was first published in 1917 as a tentative standard, ASTM C 19, and was first adopted as ASTM E 119 in 1933. Since its introduction, the test method has been modified and updated, although its essential character has remained unchanged.

2.1 GENERAL DESCRIPTION

The test methods described in ASTM E 119 prescribe a standard fire exposure for comparing the test results of building construction assemblies. For the tests of floors and roofs, a test assembly is structurally loaded and the standard fire exposure is applied to the underside of the specimen. The assembly is evaluated for its ability to contain a fire by limiting passage of flame or hot gasses, and limiting heating of the unexposed surface, while maintaining the applied load. The assembly is given a rating, expressed in hours, based on these acceptance, or end-point, criteria. Revisions to the ASTM E 119 Standard in 1971, introduced the concept of fire endurance classifications based on two conditions of support: restrained and unrestrained.

2.2 RESTRAINT CONDITIONS

According to Appendix A4 of ASTM E 119-73, a restrained condition is “one in which expansion at the support of a load carrying element resulting from the effects of fire is resisted by forces external to the element.” In an unrestrained condition, the element is free to expand and rotate at its supports. The Standard does not address how to achieve restraint at the assembly’s supports, nor does it specify, in the case of floor assemblies, the stiffness characteristics of the restraining frame used to support an assembly.

The current standard describes a means to establish restrained and unrestrained ratings for floor assemblies from restrained test samples. The conditions of acceptance are based on limiting passage of flame or hot gasses, limiting temperatures on the unexposed surface of the slab, and failure to sustain the applied load. In addition, temperature limitations are placed on the main structural members. The location of temperature measurements on the structural members is specified in the ASTM E 119 Standard.

2.3 CONDITIONS OF ACCEPTANCE

The ASTM Standard Fire Test (ASTM 2000) is conducted by exposing a specimen to a standard fire controlled to achieve specified temperatures throughout a specified time period. It is emphasized in the Standard that the fire exposure “is not representative of all fire conditions because conditions vary with changes in the amount, nature and distribution of fire loading, ventilation, compartment size and configuration, and heat sink characteristics of the compartment.” The conditions of acceptance relate

directly to the fire by limiting passage of flame or hot gasses and heating of the unexposed surface while maintaining the applied load. For floor and roof assemblies, the Standard provides for:

- Measurement of transmission of heat,
- Measurement of the transmission of hot gasses,
- Measurement of the load carrying ability of the test specimen during the test exposure.

Further, the Standard states specifically that it does not provide for, among other things, the following:

- Full information as to performance of assemblies constructed with components or lengths other than those tested,
- The effect of fire endurance of conventional openings in the assembly, that is, electrical receptacle outlets, plumbing pipe, etc., unless specifically provided for in the construction.

For tests of floors and roofs, a superimposed load is applied “to simulate a maximum load condition,” which is determined as “the maximum load condition allowed under nationally recognized structural design criteria.”

Temperatures of the floor assembly are measured during the fire exposure using thermocouples located on both the supporting steel members and top and bottom of the concrete slab.

Chapter 3

DESCRIPTION OF WTC FLOOR SYSTEM AND SFRM

3.1 COMPOSITE SLAB FLOOR SYSTEM

The floor system design for the World Trade Center (WTC) towers consisted of a lightweight concrete floor slab supported by steel trusses bridging between the building's core columns and exterior wall columns⁷. The main composite trusses, which were used in pairs, were spaced at 6 ft 8 in. on center (o.c.) and had a nominal clear span of either 60 ft or 35 ft. The steel trusses were fabricated using double angles for the top and bottom chords, and round bars for the webs. The web members protruded above the top chord in the form of a “knuckle” which was embedded in the concrete slab to develop composite action. Additionally, the floor system included bridging trusses (perpendicular to main trusses) spaced 13 ft 4 in. o.c. In the corners of the towers, the bridging trusses acted with the main trusses to provide two-way slab action, i.e., bending moments existed in both principal directions. Figure 3–1 is a cut-away of the composite floor system showing the main and bridging trusses, metal deck, and concrete slab.

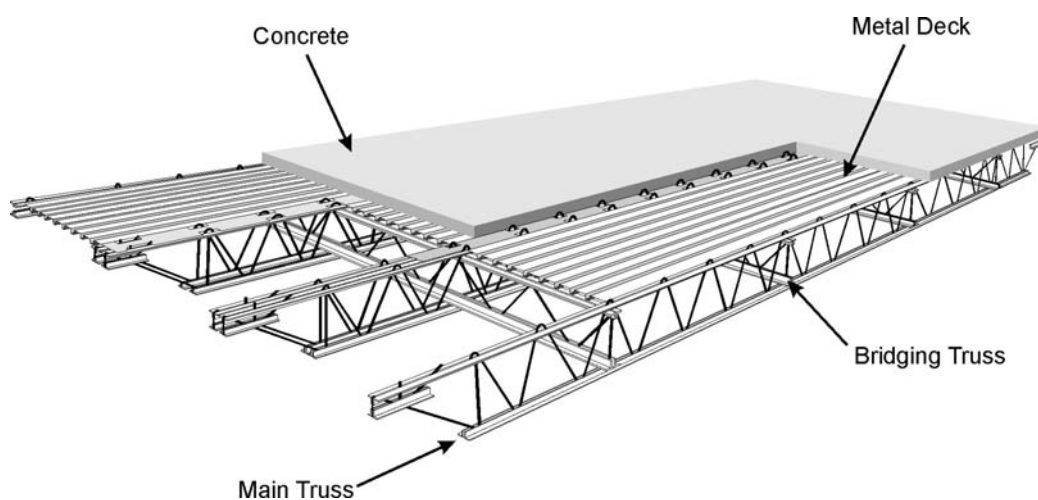

Figure 3–1. Floor system of the WTC towers.

3.2 STEEL TRUSSES

The steel trusses for the floor system were manufactured by Laclede Steel Co. using the resistance welding process to join the web, generally formed by bending a single steel rod, to the double angles forming the chord members. Resistance welding melts the two pieces being joined and fuses them to make the weld. The angles, which were produced by Laclede Steel Co., were specially rolled with a

⁷ All information and data related to the design and construction of the WTC floor system were obtained from contract drawings provided to NIST by The Port Authority of New York and New Jersey. Refer to NIST NCSTAR 1-2A for a complete description of the WTC structural system and index of all structural drawings.

convex protrusion on the outside surface of one leg which melted locally where the angle leg was joined to the round bar webs.

3.3 SFRM THICKNESS

As noted in Section 1.3, the average thickness of SFRM as originally installed was approximately $\frac{3}{4}$ in. The thicknesses of $\frac{1}{2}$ in. representing the specified thickness, and $\frac{3}{4}$ in. representing average applied thickness, were used in the standard fire resistance tests described here (see NIST NCSTAR 1-6A).

Chapter 4

FLOOR TEST ASSEMBLIES

4.1 DESIGN OF TESTS

For floor and roof assemblies, the ASTM E 119 Standard requires that the area exposed to fire be a minimum of 180 ft² and that neither dimension of the furnace be less than 12 ft. Furnaces available today (2005) in the United States for conducting standardized fire resistance tests of floor and roof assemblies have a maximum span less than 18 ft (Beitel 2002). Traditionally, relatively light construction floor assemblies have been tested, and results have been scaled to practical floor system dimensions.

4.1.1 Span of Test Assembly

The floor system used in the World Trade Center (WTC) spanned either 35 ft or 60 ft. The Underwriters Laboratories of Canada fire testing facility in Toronto (ULC) has a furnace with nominal dimensions of 35 ft by 14 ft, thereby allowing full-scale tests of the 35 ft span floor assemblies. For this series of tests, the floor truss designated on Laclede drawings as C32T5 was selected. This truss type was the most common 35 ft-span truss in the floors affected by the aircraft impact and subsequent fires (see Appendix G of NIST NCSTAR 1-2A).

As noted in Section 1.1, one of the motivations for conducting the standard fire resistance tests was to determine the technical basis for the selection of the SFRM for the WTC floor trusses and of the thickness to achieve a 2 h rating. Since test furnaces available at the time of the initial design of the WTC towers had a maximum span on the order of 18 ft, it would have been impractical to test a full-scale assembly although that possibility was raised in discussions between the Port Authority, the building designer, and steel truss fabricator (see NIST NCSTAR 1-6A). In designing a reduced-scale test, it is important to scale appropriately to capture, as nearly as practical, the conditions used for rating an assembly, namely the transmission of heat, the transmission of hot gasses, and the load-carrying ability of the test assembly during the period of fire exposure.

Both the thermal and mechanical properties of the materials and components used in the test assembly are important to its performance in a standard fire test. Likewise, the geometry of the test assembly, including steel member sizes, thickness of concrete slab, and overall geometric scale are determining factors in the thermal and structural performance of a test assembly. Finally, the magnitude of the applied load that represents the maximum load condition affects the structural performance of the test assembly. The fire exposure must follow the prescribed time-temperature curve given in the ASTM E 119 Standard.

4.1.2 Geometric Scaling of Floor Trusses

The prototype truss, designated C32T5, has an overall length of 35 ft 8 in. and a distance between centerlines of the bolts at the end supports of 35 ft $\frac{3}{4}$ in. The trusses for the “full-scale” test assembly had an overall length of 35 ft 0 in. as determined by the inside dimension of the reaction frame at the ULC fire test facility. The overall length of the reduced-scale specimens is 17 ft 5 $\frac{1}{2}$ in., also limited by the largest

dimension of the reaction frame used at the ULN fire test facility. Thus, the span of the reduced-scale specimen was $17.46/35.00 = 0.50$, or half that of the full-scale, or prototype, span.

A structural element in flexure, such as the floor system under study, carries both shear force and bending moment. The shear force, which governs the design of the truss web diagonals, is proportional to the magnitude of the uniform applied load on the slab multiplied by the span. If the span is reduced by one half, then the maximum shear force is reduced by one half. The bending moment controls the design of the truss chords and concrete slab and is proportional to the magnitude of the uniform applied load multiplied by the square of the span. Thus, if the span is reduced by one half, the maximum moment would be one quarter that in the prototype.

4.1.3 Concrete Slab Thickness

The heating rate of the unexposed surface of the floor assembly depends on the thermal properties of the lightweight concrete, the thickness of the floor slab, and profile of the supporting metal deck. Since the thermal properties of concrete are not easily changed, the slab thickness and deck must remain the same in the scaled specimen as in the prototype, or full-scale, specimen.

4.1.4 Steel Truss Sections

The structural response of a floor assembly subjected to an exposing fire depends on the rate at which the steel heats up since both the stiffness and strength of the steel decrease with increasing temperature. The rate at which the steel heats up is, in turn, a function of the thermal properties of the SFRM which change with temperature, the thickness of the applied SFRM, and the thermal conductivity of the steel. Since both the mechanical and thermal properties of steel and the SFRM are not easily changed, to preserve the rate at which the steel heats up and, therefore, the rate at which the steel loses its stiffness and strength, both the size of the steel sections and thickness of SFRM must be the same in the reduced-scale specimen as in the full-scale specimen.

4.1.5 Applied Load

The structural response of a floor assembly is also determined by the applied load, which the ASTM E 119 Standard defines as the maximum load condition allowed under nationally recognized structural design criteria. For the correct structural response to be captured, the stresses in the reduced-scale test assembly resulting from the applied load should match, as closely as practical, those of the prototype floor system. It is this principal upon which the loading for the reduced-scale tests was calculated.

As discussed under geometric scaling, the shear force, which is a function of the applied load and the section properties of the members, determine the stresses in the truss web diagonals. If the scale factor is one half, the applied load must be doubled to produce the same shear force. Because the section properties are not scaled, doubling the magnitude of the applied load produces the same forces in the diagonals of the reduced-scale assembly as in the prototype. The allowable compressive stress is governed by inelastic buckling and does not scale in exactly the same way, that is, the allowable compressive stress for the web diagonals in the reduced-scale assembly is greater than that for the web diagonals in the full-scale assembly.

The stresses in the chord members and in the concrete slab are a function of the applied load and span (bending moment) and the geometry of the assembly and geometric section properties of the structural elements. Because the bending moment is a function of the applied load and the square of the span (see above), for a scale factor of 0.50 and an applied load approximately twice that of the prototype design load, the bending moment is half that of the prototype. The force in the chord members is computed from statics and is a function of the applied load and the depth of the truss. Since the moment is one half and the depth of the floor section is approximately one half, the stresses in the truss chord members of the reduced-scale assembly are roughly equal to those of the prototype.

The loading was calculated to satisfy design requirements of the *Specification for the Design, Fabrication & Erection of Structural Steel for Buildings*, which were the nationally recognized structural design criteria under which the floor system for the WTC towers was designed (AISC 1963). A complete description of the specimen loading is presented in Section 4.4

Doubling of the applied load (expressed in force per unit length) on a composite double truss floor system as discussed above is achievable with the loading devices available. However, if the distance between trusses is scaled by the factor of one half, then the load per unit area would be four times that applied to the prototype full-scale assembly. Since this magnitude of loading would be difficult to achieve and the consequences of a structural failure at elevated temperatures would be catastrophic under such a load, the truss spacing for the reduced-scale tests was not scaled from the full-scale configuration. Since the trusses are each loaded to their design capacity, the spacing would not be expected to influence the test results significantly.

4.2 MATERIALS OF CONSTRUCTION

Every attempt was made to duplicate conditions that existed at the time of construction of the WTC floor system, including geometry and section properties of structural components, materials of construction, and fabrication and construction techniques. This chapter addresses the selection of materials and components and the level of care taken to insure faithful duplication of the floor system found in the WTC towers. Properties of the steels, concrete, metal deck, welded wire fabric, etc. used in the construction of all four test assemblies are documented in this section. Properties of concrete and sprayed fire-resistive material, which varied for each test specimen, are reported in the next section.

4.2.1 Fabrication of Trusses

As will be addressed in Section 4.2.3, resistance welding, which was used in the fabrication of the WTC trusses, was not employed in the fabrication of the test assembly trusses. Consequently, the specially rolled angles with a convex protrusion were not necessary. Conventional hot-rolled steel angles were used and, since unequal-leg angles were not available in the size required, equal-leg angles were cut (sheared) to the appropriate dimension.

The main and bridging trusses were fabricated by Canam Steel Co. under subcontract to Underwriters Laboratories Inc. (UL). Dimensions were taken from Laclede Steel shop drawings and scaled for the 35 ft and 17 ft span test frames. The 35 ft long trusses, Test Specimens 1 and 2, were scaled from 35 ft 8 in., the total length of the C32T5 truss, to a length of 35 ft 5 in. to fit the dimensions of UL's test

frame in the Toronto fire test facility. The overall depth of the truss was scaled accordingly. Figures 4–1 and 4–2 show the dimensions of the full-scale test specimen main trusses.

The 17 ft trusses, Test Specimens 3 and 4, were scaled to fit the test frame in UL’s Northbrook facility; that is, by the ratio of 17 ft 5½ in. to 35 ft 8 in. The height of the knuckle was not changed since the depth of concrete slab was the same for both full- and reduced-scale tests. All member sizes, both chord and web, were unchanged. Figures 4–3 and 4–4 show the dimensions of the reduced-scale test specimen main trusses.

The bridging trusses for the full-scale test assembly were scaled in the same manner as the main trusses. For the reduced-scale tests, since the truss spacing was not scaled (see Section 4.1.5) the depth of the truss was scaled per the main trusses but the length (i.e., spacing of knuckles) was not. Figures 4–5 and 4–6 show the dimensions of the full- and reduced-scale bridging trusses, respectively.

4.2.2 Steel Grade

The original C32T5 trusses in the WTC were fabricated from ASTM A242 grade steel according to WTC contract drawings and confirmed by NIST (see NIST NCSTAR 1-3D). Since this steel is no longer produced, it was determined that ASTM A 572 Gr. 50 was an acceptable substitute, considering both chemistry and mechanical properties. The truss fabricator was not able to obtain the steel used for the web members in A572 grade steel in a time frame that would not impact the project. It was further decided that ASTM A529 grade steel was an acceptable substitute and would be used for the truss webs while, ASTM A572 grade steel would be used for the chord members. Chemistry, mechanical properties, and weldability were all considered in making this determination. Certified Mill Test Reports (CMTR) for the steel used to fabricate the main trusses and bridging trusses are shown in Appendix A.

4.2.3 Truss Welds

Most of the original WTC truss welds were made using resistance welding and the remainder using the submerged metal arc welding (SMAW) process (see Jefferson, 1962). Resistance welding is no longer widely used in practice, and no fabricator could be located that employed this technique. It was determined that metal inert gas (MIG) welding (Jefferson, 1962) could be used for all welds to fabricate the trusses.

The specification for the fabrication of the floor trusses⁸ states, in section 105 Quality Control and Inspection of Resistance Welding,

“All interior truss panel points will be connected by electronically controlled resistance welding designed to provide a minimum of two times the strength of the connected members at full design load.”

The strength of a resistance weld is a function of the size of the pieces being joined, and parameters of the welding process such as heat (current), applied pressure, holding time, etc. For the WTC contract, Laclede developed 29 resistance weld designations for the various combinations of double chord angle

⁸ World Trade Center Contract WTC-221.00, Fabricated Steel Floor Trusses, Bridging, Beams and Bracing for Prefabricated floor Units for North and South Towers, dated October, 1967 (WTCI-71-I)

size and web rod size (see Table 4–1) Test Weld Strengths for many of the designations were found in a review of Laclede WTC Quality Control program documents and are also shown in Table 4–1. Welds designated R-22 were used for the fabrication of the C32T5 and are reported as having a Test Weld Strength (design strength) of 24 kips. Laclede WTC Quality Control Data (load test data) were found for 20 of the 29 designations; R-22 was not among them. The test data found showed results for ten load tests and the average load at failure is reported in Table 4–1. Dividing the failure load by the design load one obtains, in essence, a factor of safety which is also reported in the last column of Table 4–1. The average of these values was found to be 2.02. Thus, it could be concluded that the resistance weld procedure used by Laclede Steel Company in the fabrication of the floor trusses, produced welds with two times the design strength as called for in the contract specification.

Table 4–1. Redistance Weld Data.

Resistance Weld Designation	Double Chord Angle Size	Web Rod Size (in.)	Test Weld Strength (Kip)	Average Load (Kip)	F.S.
R-1	3 x 2 x 0.37	1.14	45	81	1.80
R-2	3 x 2 x 0.37	1.09	45	82	1.82
R-3	3 x 2 x 0.37	0.98		68	
R-4	3 x 2 x 0.37	0.92		63	
R-5	3 x 2 x 0.33	1.14	40	77.5	1.94
R-6	3 x 2 x 0.33	1.09	40	73.6	1.84
R-7	3 x 2 x 0.33	0.98	32	65.6	2.05
R-8	3 x 2 x 0.33	0.92	28	62.4	2.23
R-9	2 x 1-1/2 x 0.37	1.14	38	67.1	1.76
R-10	2 x 1-1/2 x 0.37	1.09		65.8	
R-11	2 x 1-1/2 x 0.37	0.98		60.7	
R-12	2 x 1-1/2 x 0.37	0.92		56.9	
R-13	2 x 1-1/2 x 0.37	0.75			
R-14	2 x 1-1/2 x 0.31	1.14	40	66.5	1.66
R-15	2 x 1-1/2 x 0.31	1.09	38	65.2	1.71
R-16	2 x 1-1/2 x 0.31	0.98	30	60.1	2.00
R-17	2 x 1-1/2 x 0.31	0.92	25	56.8	2.27
R-18	2 x 1-1/2 x 0.31	0.75	40		
R-19	2 x 1-1/2 x 0.25	1.14	40	75.4	1.88
R-20	2 x 1-1/2 x 0.25	1.09	40	73.7	1.84
R-21	2 x 1-1/2 x 0.25	0.98	29		
R-22	2 x 1-1/2 x 0.25	0.92	25		
R-23	2 x 1-1/2 x 0.25	0.75			

Resistance Weld Designation	Double Chord Angle Size	Web Rod Size (in.)	Test Weld Strength (Kip)	Average Load (Kip)	F.S.
R-24	1-1/2 x 1-1/4 x 0.275	0.98	18	44.8	2.49
R-25	1-1/2 x 1-1/4 x 0.275	0.92	18	41.1	2.28
R-26	1-1/2 x 1-1/4 x 0.275	0.75			
R-27	1-1/2 x 1-1/4 x 0.230	0.98	16	38.5	2.40
R-28	1-1/2 x 1-1/4 x 0.230	0.92	16	37.9	2.37
R-29	1-1/2 x 1-1/4 x 0.230	0.75	16		
				Average	2.02

The inherent factor of safety of welds designed in accordance with AISC, may be estimated by dividing the nominal strength of a groove weld in shear (AISC 1999) by the allowable stress of a groove weld in shear (AISC 2001), or $0.6 F_y / 0.3 F_y = 2.0$. To reproduce, approximately, the strengths of the resistance welds used in the fabrication of the WTC floor trusses, NIST used metal inert gas (MIG) welds designed to meet the strength requirements of AISC specifications (AISC 2001). The MIG process uses small gauge wire, well suited for producing the flare-bevel groove welds joining the round web bars to the double chord angles.

4.2.4 Metal Deck

The non-composite deck consisted of 1½ in. No. 22 gauge galvanized sheet metal floor units. Each full panel measured 35 ft 2 in. long by 3 ft 1½ in. wide for Assembly Nos. 1 and 2, and 17 ft 8 in. by 3 ft 1½ in. wide for Assembly Nos. 3 and 4. The original deck used for the floor system in the WTC towers was custom produced specifically for the WTC buildings. The steel deck was rolled in widths that spanned between trusses without a longitudinal seam. It was not possible to obtain deck in the desired span, and therefore, it was determined that typical Type B steel deck, seamed per the manufacturer's recommendation, would be acceptable.

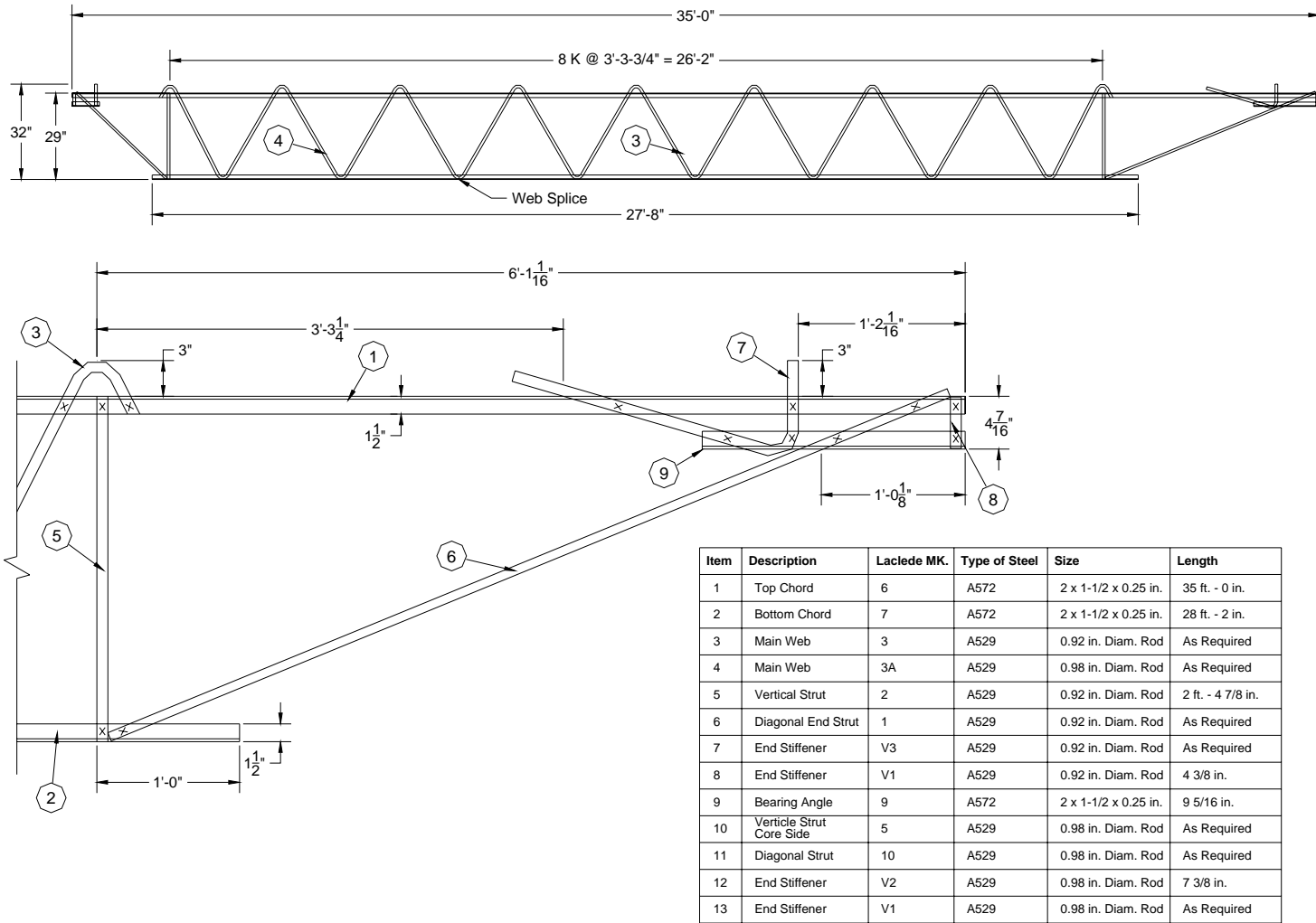
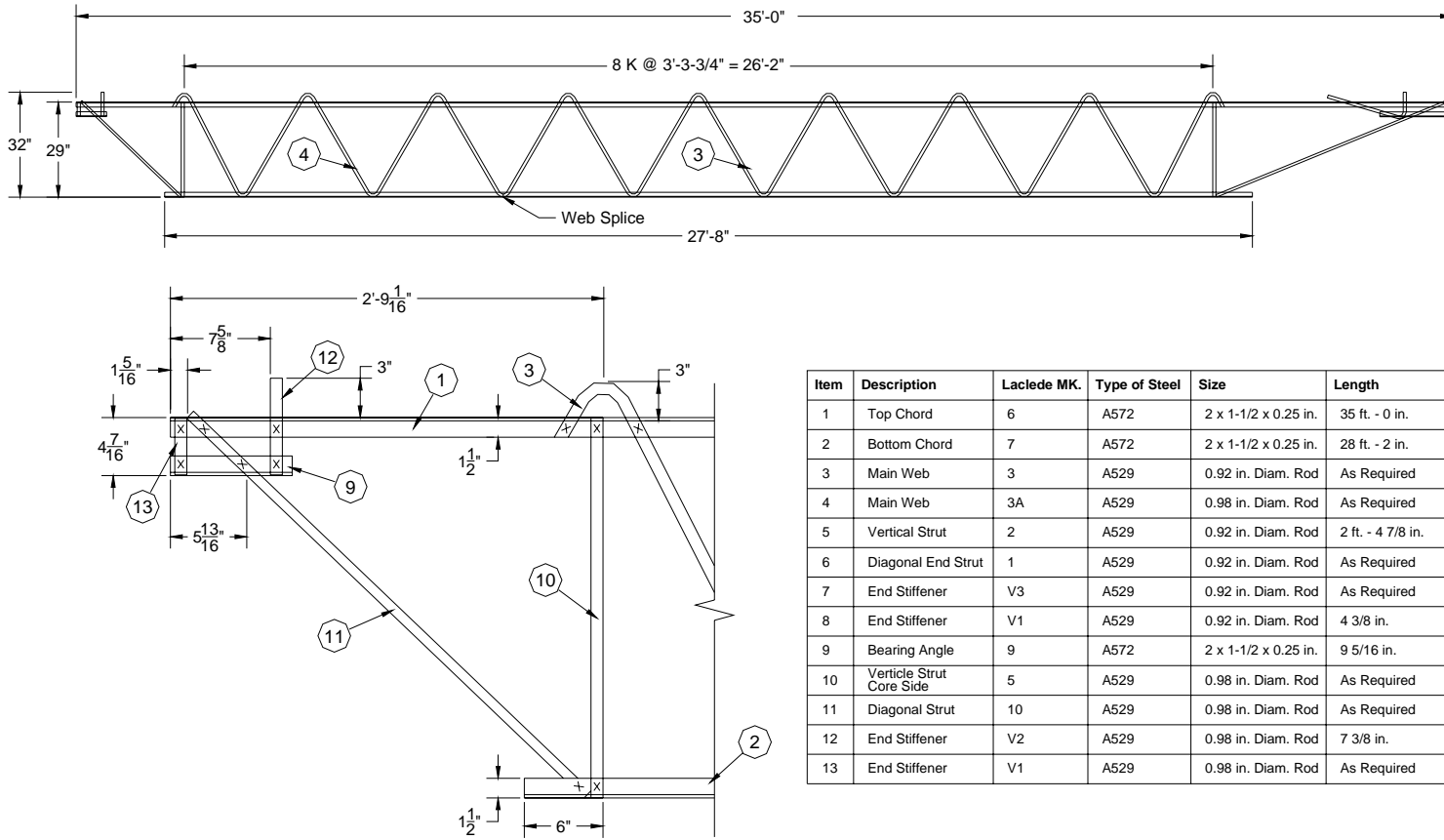

Figure 4-1. 35 ft main truss, column end.



Item	Description	Laclede MK.	Type of Steel	Size	Length
1	Top Chord	6	A572	2 x 1-1/2 x 0.25 in.	35 ft. - 0 in.
2	Bottom Chord	7	A572	2 x 1-1/2 x 0.25 in.	28 ft. - 2 in.
3	Main Web	3	A529	0.92 in. Diam. Rod	As Required
4	Main Web	3A	A529	0.98 in. Diam. Rod	As Required
5	Vertical Strut	2	A529	0.92 in. Diam. Rod	2 ft. - 4 7/8 in.
6	Diagonal End Strut	1	A529	0.92 in. Diam. Rod	As Required
7	End Stiffener	V3	A529	0.92 in. Diam. Rod	As Required
8	End Stiffener	V1	A529	0.92 in. Diam. Rod	4 3/8 in.
9	Bearing Angle	9	A572	2 x 1-1/2 x 0.25 in.	9 5/16 in.
10	Verticle Strut Core Side	5	A529	0.98 in. Diam. Rod	As Required
11	Diagonal Strut	10	A529	0.98 in. Diam. Rod	As Required
12	End Stiffener	V2	A529	0.98 in. Diam. Rod	7 3/8 in.
13	End Stiffener	V1	A529	0.98 in. Diam. Rod	As Required

Figure 4-2. 35 ft main truss, core end.

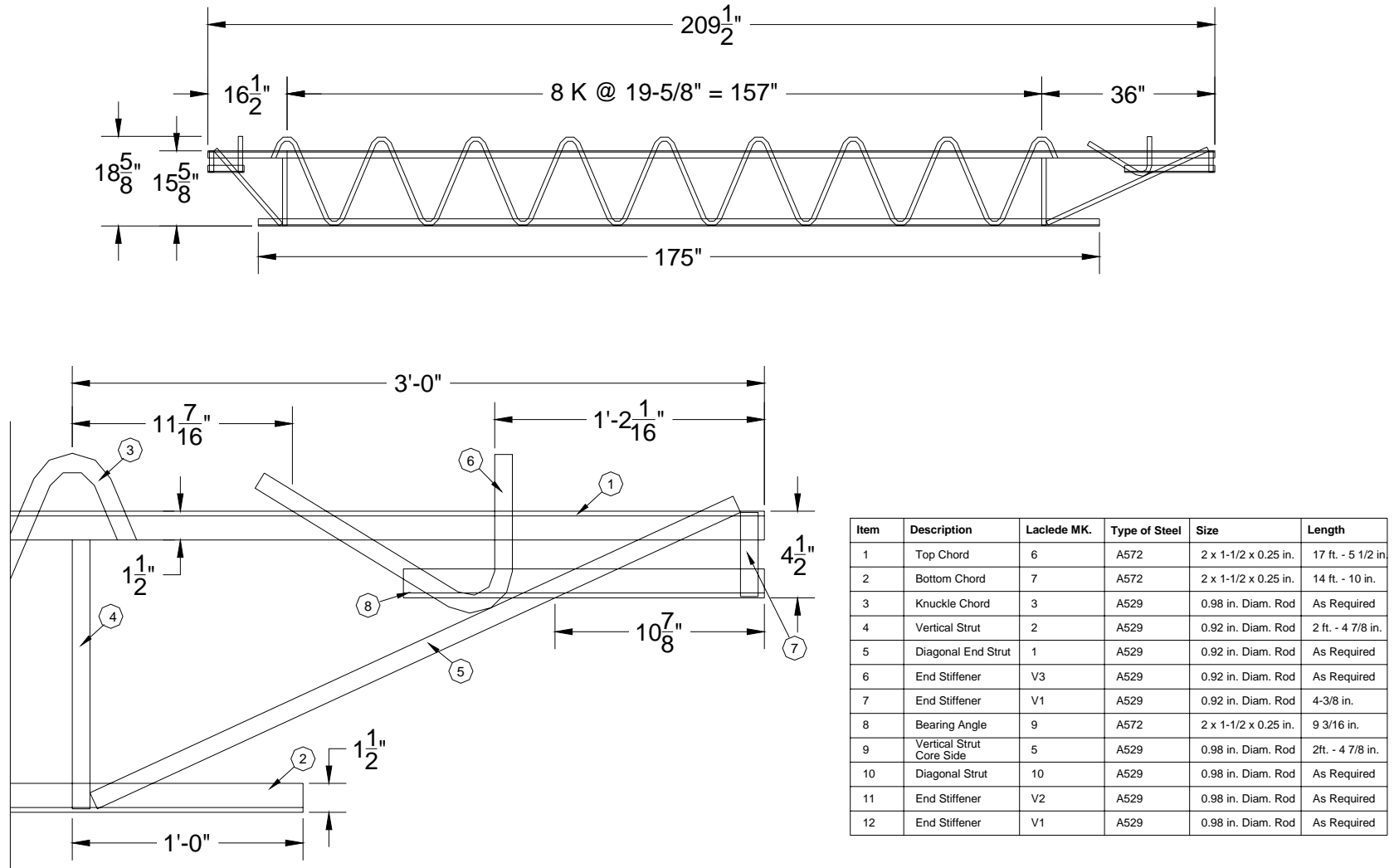

Figure 4-3. 17 ft main truss, column end.

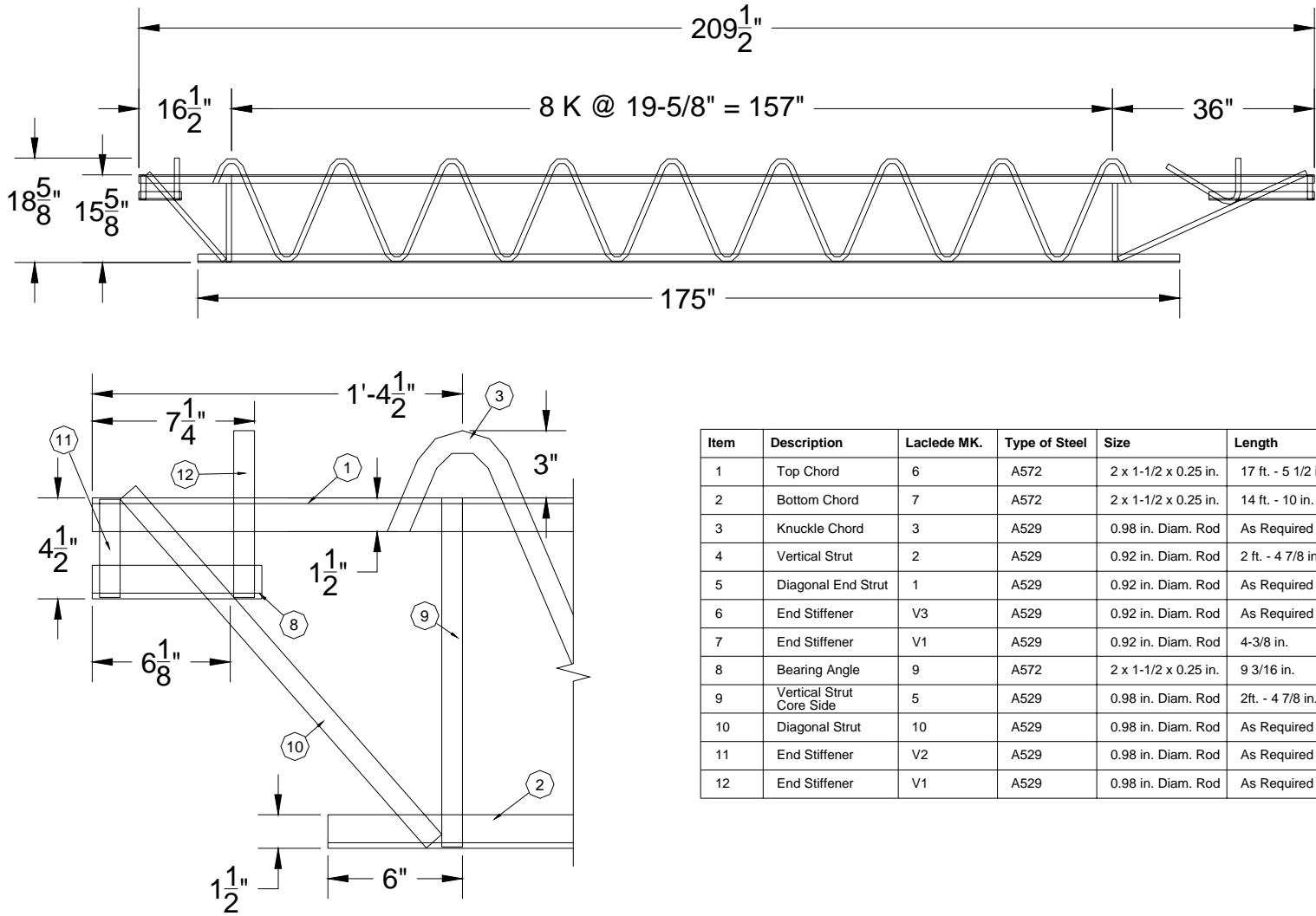
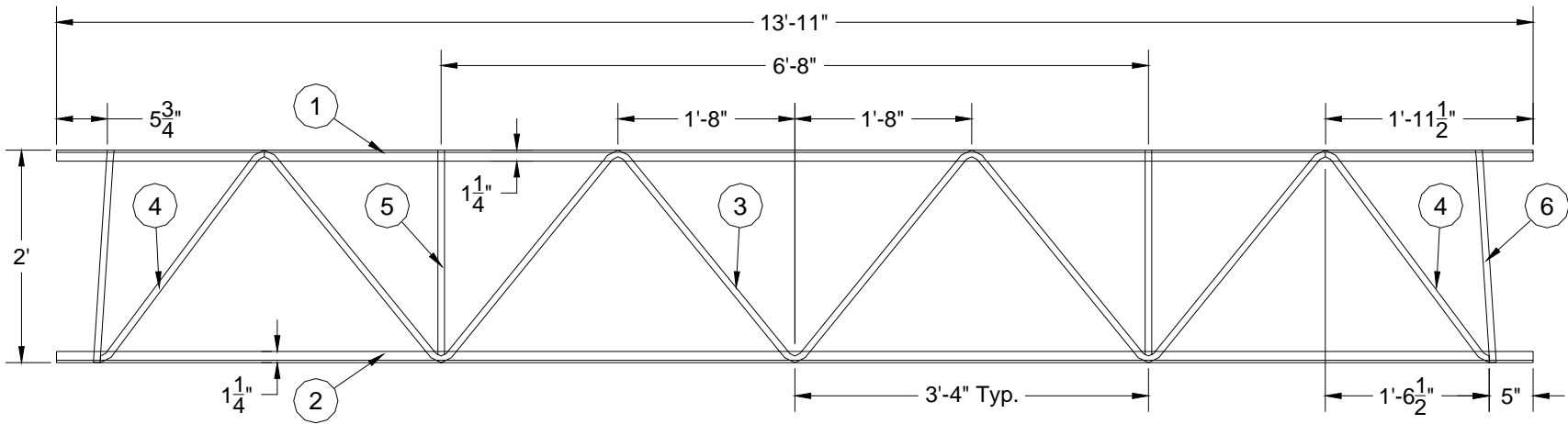
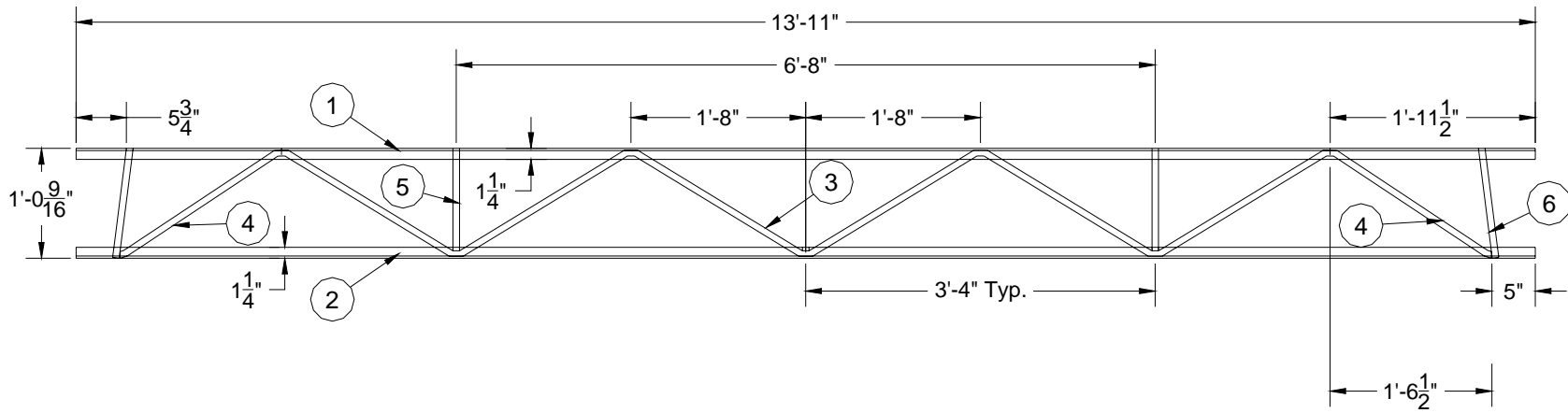

Figure 4-4. 17 ft main truss, core end.



Item	Description	Laclede MK.	Type of Steel	Size	Length
1	Top Chord	6	A572	1-1/2 x 1-1/4 x 0.230 in.	13 ft. - 8 in.
2	Bottom Chord	7	A572	1-1/2 x 1-1/4 x 0.230 in.	13 ft. - 8 in.
3	Main Web	3	A572	0.75 in. Diam. Rod	As Required
4	Web Chord	4	A572	0.75 in. Diam. Rod	As Required
5	Vertical Strut	12	A572	0.75 in. Diam. Rod	1 ft. - 10-7/8 in.
6	Inclined End Strut	2	A572	0.75 in. Diam. Rod	1 ft. - 11-3/4 in.

Figure 4-5. Bridging truss for Assemblies Nos. 1 and 2.



Item	Description	Laclede MK.	Type of Steel	Size	Length
1	Top Chord	6	A572	1-1/2 x 1-1/4 x 0.230 in.	13 ft. - 11 in.
2	Bottom Chord	7	A572	1-1/2 x 1-1/4 x 0.230 in.	13 ft. - 11 in.
3	Main Web	3	A572	0.75 in. Diam. Rod	As Required
4	Web Chord	4	A572	0.75 in. Diam. Rod	As Required
5	Vertical Strut	12	A572	0.75 in. Diam. Rod	As Required
6	Inclined End Strut	2	A572	0.75 in. Diam. Rod	As Required

Figure 4–6. Bridging truss for Assemblies Nos. 3 and 4.

4.2.5 Welded Wire Fabric

The welded wire fabric used in the concrete was 10 in. by 4 in. W4.2/W4.3 welded steel mesh. Steel wire was supplied by Insteel Wire Products and its strength shown in Appendix A.

4.2.6 Concrete

The concrete design strength for a typical office floor of the WTC was specified to be 3,000 psi, and the lightweight density was specified as 100 pcf. The concrete for the floor slab consisted of ¾ in. lightweight haydite aggregate, sand, Type I Portland cement and water. No records of actual mixture proportions or cylinder strengths were found in NIST's review of available documents. The mix design shown in Table 4–2 was determined by the concrete supplier to produce a 3,000 psi 28-day strength using lightweight aggregate.

Table 4–2. Concrete mix design per cubic yard of concrete.

Cement (lb)	Haydite "C" (lb)	Sand (lb)	Entrained Air (%)	Water (lb)
522	940	1300	6	281*

* Includes 40 lb of water in sand

4.2.7 Primer

The trusses supplied by Laclede Steel were shop primed during production using an electro-deposition process. The formulation for the primer was designated as Formula LREP – 10001 and was found in Laclede files (see Appendix B). The exact formulation could not be reproduced due to current environmental considerations. A stock structural steel primer, manufactured by Sherwin Williams and designated Type B50NV11 (recommended by Isolatek International, the manufacturer of the sprayed fire-resistive material used in these tests and in the original construction of the WTC towers) was determined to be an acceptable substitute. The primer was field applied to the trusses after assembly in the ULN and ULC fire test facilities.

4.2.8 Sprayed Fire-Resistive Materials

The sprayed fire resistive material used on the test assemblies was BLAZE-SHIELD DC/F which is manufactured by Isolatek International, and is the same product as that applied during original construction.

4.2.9 Miscellaneous Steel

Miscellaneous steel including rebar, pourstop coverplates, and support angles used during construction are described in Section 4.3.

4.3 CONSTRUCTION OF TEST ASSEMBLIES

The construction of each assembly was conducted by UL technical staff and under the supervision of NIST at Underwriters' Laboratories of Canada (ULC), and Underwriters Laboratories Inc. in Northbrook, Illinois (ULN). All welds were made by certified welders and inspected by STS Consultants Ltd. (STS) under sub-contract to UL. Table 4-3 lists the construction periods and test dates for the four assemblies tested.

Table 4-3. General construction details.

Assembly No.	Description	Location	Construction Dates	Test Date
1	35 ft Restrained	Toronto, ON, Canada	1/20/2004 - 1/27/2004	8/7/2004
2	35 ft Unrestrained	Toronto, ON, Canada	1/28/2004 - 2/04/2004	8/11/2004
3	17 ft Restrained	Northbrook, IL, U.S.	2/13/2004 - 2/22/2004	8/19/2004
4	17 ft Restrained w/ unprotected bridging trusses	Northbrook, IL, U.S.	2/13/2004 - 2/22/2004	8/25/2004

4.3.1 Construction of 35 Ft Assemblies

Assembly No. 1 was restrained from thermal expansion. The trusses were welded to steel support angles that were attached to the test frame, and the concrete was poured in contact with the frame. Assembly No. 2 was unrestrained. The trusses were bolted to steel support angles having a 2⁷/₈ in. slot to allow for unrestrained thermal expansion. The concrete was poured with a 1¹/₂ in. gap between the concrete and the frame. Figure 4-7 shows the assembly of the steel support system for test Assembly No. 1. Refer to Appendix C for construction drawings.

Structural Steel Frame and Deck

The two nominal 35 ft by 14 ft floor assemblies were constructed of the same materials and in the same manner, with the exception of the restraint condition, provided by the attachment of the main trusses to the test frame as described above. Two main trusses were symmetrically positioned in the test frame, 6 ft 8 in. o.c.

The ends of the main trusses in Test Assembly No. 1 were supported by L6×4×1 structural angles 12 in. long welded to the test frame. The bearing length for each main truss was 3¹/₂ in. The ends of the main trusses were welded with a 1/2 in. fillet along the entire bearing length on each side of the trusses (see Fig. 4-8). Steel plates were placed between the ends of the main trusses and the test frame, filling the gap and, thus, preventing thermal expansion.



Source: NIST.

Figure 4–7. Structural steel frame of Assembly No. 1.



Source: NIST.

Figure 4–8. Restrained end condition of Assembly No. 1 prior to shimming.

The ends of the main trusses in Test Assembly No. 2 were supported on L7×4×1 structural angles, 14 in. long welded to the test frame. Slotted holes, 2 7/8 in. long, were provided in the steel angles, and the

centerline of each slot was located 3 in. from the edge of the angle. The edge distance of the slotted holes was 1¼ in. The bolt holes in the truss bearing angles were 15/16 in. in diameter. The main trusses were bolted to the support angles using two 7/8 in. diameter by 2½ in. long ASTM A325 bolts with ASTM F436 washers and ASTM A563 nuts as seen in Fig. 4–9. The nuts were hand tightened to provide connection stability without hindering thermal expansion. Also, the trusses and supports were designed so that the bolts were installed close to the inside edge of the slot, thus allowing the maximum unrestrained outward movement as the test specimens heated and expanded. The slots extending beyond the edge of the truss support angles are just visible in Fig. 4–13.



Source: NIST.

Figure 4–9. Unrestrained end condition of Assembly No. 2.

Two bridging trusses, one located 9 ft 4 in. from the west test frame edge and one located 12 ft 7¼ in. from the east test frame edge were installed in the assembly. The bridging trusses were welded to 6 in. long L2½×1½×½ angles that were welded to the bottom chord of each main truss. The top of the bridging truss was welded to the top chord of the main truss. All welds were ¼ in. fillets.

Three L3×2×¼ in. steel deck support angles, one located 3 ft ¾ in. from the west test frame edge, one at 16 ft 1 in. from the west test frame edge, and one at 6 ft 5 in. from the east test frame edge were welded to the bottom of the top chord of the main truss (see Fig. 4–10).



Source: NIST.

Figure 4–10. Intersection of deck support angle and main truss.

At the intersection of the bridging trusses, steel deck support angles, and main trusses, a 3 in. by 3 in. by $\frac{3}{8}$ in. steel plate was welded to the top side of the bottom chord of the main truss with $\frac{1}{4}$ in. fillet on the east and west sides of the plate. There was no steel plate welded to the bottom chord at the location of the center steel deck support angle.

Cover plates made from A36 steel, 7 in. wide and 0.116 in. thick were welded to the full length of the top chords of the main trusses to prevent the wet concrete from passing through (Fig. 4–10). Steel cover plates measuring $3\frac{1}{2}$ in. by 7 in. by 0.116 in. thick were welded under each web knuckle for the same purpose. A 2 in. by 7 in. by $\frac{1}{4}$ in. steel plate was welded to adjacent knuckles (Fig. 4–11) per Laclede shop drawings. The plates were located at the knuckles immediately above the intersection of bridging trusses and deck support angles with the main trusses (see Fig. 4–12). A $6\frac{1}{4}$ in. long piece of No. 8 reinforcing steel bar was welded to each end stiffener at both ends of the truss (see Fig. 4–13).



Source: NIST.

Figure 4–11. Cover plates on main truss.



Source: NIST.

Figure 4–12. Intersection of main and bridging truss, bottom chord.



Source: NIST.

Figure 4–13. Detail of rebar welded to end stiffener.

The steel floor deck was placed on the assembly in 3 ft 1½ in. widths, 35 ft lengths, with the crests and valleys parallel to the main trusses (Fig. 4–14). Near the east-west centerline of the assembly the deck was overlapped and secured with ⅝ in. long self-taping hex-head screws spaced 18 in. o.c., beginning 16 in. from the east edge of the frame. At the interface of the steel deck edge and the upper chords of the main trusses, the deck was secured to the chords with ½ in. puddle welds spaced 6 in. o.c. Where the deck met the north and south test frame edges, 4¼ in. by 96 in. by 0.116 in. thick steel plate was secured to the top of the steel deck with 1¼ in. long by 5/32 in. shank hex-head, self-tapping screws spaced 18 in. o.c., located 1½ in. from the edge of the steel plate. The steel plate was installed so that it was flush against the test frame surface.



Source: NIST.

Figure 4–14. Placement of steel form deck.

Chairs, $\frac{3}{4}$ in. high measuring 60 in. long, with 12 legs per chair spaced 5 in. o.c. and $2\frac{3}{4}$ in. from each end, were placed and taped on alternating deck crests along the full length of the assembly (see Fig. 4–15). Welded wire fabric (WWF), 10 in. by 4 in. W4.2/W4.3, supplied in 60 in. widths, was placed on the chairs with the 4 in. dimension running the length of the assembly (east to west). The WWF was notched to fit around the knuckles and instrumentation sleeves. Adjacent sections of WWF were overlapped nominally 12 in. per ACI 318-63 (ACI, 1963). At the overlaps, the mesh was secured with 18 gauge wire twist-ties spaced approximately 24 in. o.c.

No. 4 ($\frac{1}{2}$ in. or 13 mm diameter) steel reinforcing bar was placed on top of the first layer of welded wire fabric, 3 in. from the east and west ends of the test frame. A second layer of welded wire fabric was installed with overlaps and fastened with wire ties as described above for the first layer. Two lengths of No. 5 ($\frac{5}{8}$ in. or 16 mm diameter) steel reinforcing bar were placed on both sides of each bridging truss over the second layer of wire fabric (Fig. 4–16). The rebar was secured to the top layer of welded wire fabric with 18 gauge wire twist-tied approximately 24 in. o.c.



Source: NIST.

Figure 4–15. Chairs for welded wire fabric.



Source: NIST.

Figure 4–16. Welded wire fabric.

Concrete Placement

The ready-mixed concrete was poured to an average depth of 4 in. measured from the top plane of the 1½ in. deep steel deck. Details of the concrete mix and compressive strengths are given in Table 4–4. The concrete was finished to a flat, smooth surface with a wooden trowel. Placement of concrete is shown in Fig. 4–17.

Table 4–4. Details of concrete placement.

Assembly No.	Concrete Pour Date	Wet Unit Weight* (lb/ft ³)	Slump* (in.)	Air Content* (%)	Water Added (gal)	Compressive Strength at 28 Days (psi)	Compressive Strength at 56 days (psi)
1	1/27/2004	114.2/114.8	6/8	4.5/5.75	4	4177	4735
2	2/4/2004	109.4 lb/ft ³	7.5	8.75%	–	2937	3893

*Results before and after water added



Source: NIST.

Figure 4–17. Concrete placement.

Curing of Concrete

The ASTM E 119 test standard requires the average relative humidity of the concrete slab to be 70 percent +/-5 percent. In order to accelerate the process of driving the moisture out of the concrete slab, the assemblies were placed in a high temperature, low humidity environment following an initial 28 day curing at ambient environment. The relative humidity of each slab was monitored regularly in accordance with the method described in ASTM E 119-2000a, paragraph 12.1.3, Note 6.

Preparation of Trusses

Prior to the application of primer to the structural steel members, the steel was sand blasted (Fig. 4–18) to the Society of Protective Coatings SSPC-SP6 specification in accordance with the product specification sheet of the primer. Following the sand blasting, the steel was primed (Fig. 4–19) with Sherwin Williams Type B50NV11 at an approximate dry film thickness of 0.003 in.



Source: NIST.

Figure 4–18. Sandblasted assembly.



Source: NIST.

Figure 4–19. Primer on bridging truss.

Instrumentation

Prior to the concrete pour, four 18-gauge Type K thermocouples were attached to the steel form deck at each of three locations, near the center point and quarter points in the east-west direction. At each location, a thermocouple was placed in the valley, sidewall, crest, and next adjacent valley of the deck. Refer to Appendix D for locations of deck thermocouples.

After priming of the structural steel, 18-gauge Type K thermocouples were attached to each main and bridging truss (see Fig. 4–20). Eight thermocouples were peened into the steel at each cross section, located approximately at the quarter and center points on each main truss (see Appendix D for exact locations). Additionally, 10 thermocouples were located at the intersections of each main and bridging truss. In total, 44 thermocouples were attached to each main truss, for a total of 88 thermocouples.

On each bridging truss, four thermocouples were attached at each cross section located at the center of the truss, at the intersections of the main and bridging trusses, and approximately halfway between the main truss and the end of the bridging truss (see Appendix D for exact locations). In total, 16 thermocouples were attached to each bridging truss, for a total of 32 thermocouples.

Strain gauges were attached on the bottom chords of the main trusses to measure strain as each test assembly was loaded. A pre-wired 350 Ω resistance strain gauge was placed, per the manufacturer's instructions, on the top surface and bottom surface of the bottom chord angle. The strain gauges were symmetrically opposed, at the mid-length of the bottom chord of each main truss. Each pair of gauges was wired to a half-bridge amplifier prior to loading of the assembly. Strain gauge readings were used to confirm proper loading of the assemblies, and the wiring was cut and bridge circuit removed prior to the start of the tests.



Source: NIST.

Figure 4–20. Peened thermocouples on truss.

Application of Sprayed Fire Resistive Materials

Application of the sprayed fire resistive materials was conducted by the manufacturer of the SFRM under a sub-contract to UL and witnessed by representatives of UL and NIST. On the underside of the assembly, the BLAZE-SHIELD DC/F sprayed fire resistive material was applied to the main and bridging trusses in multiple coats. No attempt was made to control overspray of material onto the deck of the 35 ft test assemblies.

Thickness and density measurements were taken in accordance with ASTM E 605 Standard Test Methods for Thickness and Density of Sprayed Fire-Resistive Material (SFRM) Applied to Structural Members (ASTM 2000a). The average SFRM thicknesses on the trusses are shown in Table 4-5 for Test Assembly No. 1. Figure 4-21 shows the SFRM on main trusses after achieving the desired thickness. Figure 4-22 shows SFRM thickness measurements being made on the bottom chord of a main truss.

Table 4-5. SFRM Thickness measurements on Assembly No. 1.

Location	Nominal Thickness (in.)	Final Average Measured Thickness (in.)	Basis: No. of Thickness Measurements
North Main Truss	3/4	0.756	254
South Main Truss	3/4	0.750	254
East Bridging Truss	3/8	0.385	72
West Bridging Truss	3/8	0.385	72

The air dry density of the Type DC/F sprayed fire resistive material was determined using 12 in. by 12 in. samples. The air dry densities are shown in Table 4-6 for Assembly No. 1. The average air dry density was found to be 15.73 pcf.

Table 4-6. Air dry density of spray applied fire resistive material on Assembly No. 1.

Material Type	Nominal Thickness (in.)	Measured Density (pcf)
DC/F	3/4	17.27
DC/F	3/4	15.19
DC/F	3/4	14.73



Source: NIST.

Figure 4-21. SFRM on main truss.



Source: NIST.

Figure 4-22. Measurement of SFRM thickness on truss chord.

SFRM thickness measurements for Test Assembly No. 2 are given in Table 4–7. Air dry density of spray applied fire resistive material on Assembly No. 2 is given in Table 4–8; the average air dry density was found to be 19.95 pcf.

Table 4–7. Thickness measurements on Assembly No. 2.

Location	Nominal Thickness (in.)	Final Average Measured Thickness (in.)	Basis: No. of Thickness Measurements
North Main Truss	3/4	0.756	254
South Main Truss	3/4	0.755	254
East Bridging Truss	3/8	0.393	72
West Bridging Truss	3/8	0.391	72

Table 4–8. Air dry density of spray applied fire resistive material on Assembly No. 2.

Material Type	Nominal Thickness, in.	Measured Density, pcf
DC/F	3/4	20.98
DC/F	3/4	24.01
DC/F	3/4	14.87

4.3.2 Construction of 17 Ft Assemblies

Structural Steel Frame and Deck

Assembly Nos. 3 and 4 were both restrained from thermal expansion by welding the trusses to the steel support angles that were attached to the test frame and by casting the concrete in contact with the frame. The sprayed fire resistive material was applied to Assembly No. 3 in the same way as for Assembly Nos. 1 and 2. Assembly No. 4 was protected with ½ in. of SFRM on the main trusses, while the bridging trusses were left unprotected, and the deck and deck support angles were shielded from any overspray (see Section 1.4). Refer to Appendix E for construction drawings.

The two nominal 17 ft by 14 ft floor assemblies were constructed in the test frames to fill the openings. Both assemblies were constructed of the same materials and in the same manner. The two main trusses were symmetrically positioned in the test frame 6 ft 8 in. o.c. (see Fig. 4–23).



Source: NIST.

Figure 4–23. Steel framing of 17 ft assembly.

The ends of the main trusses were supported on structural steel support angles installed at the north and south walls of the test frame. The resulting bearing length at each end of the main trusses was $3\frac{1}{2}$ in. The ends of the main trusses were welded with $\frac{1}{2}$ in. fillets along the entire bearing length on each side of the truss bearing angles. Steel plates were placed between the ends of the main trusses and the test frame, filling the gap and, thus, preventing thermal expansion.

Each test assembly had two bridging trusses, one located 4 ft $9\frac{5}{8}$ in. from the north test frame edge and one located 6 ft $5\frac{5}{8}$ in. from the south test frame edge. The bridging trusses were welded to 6 in. long by 1 $\frac{1}{2}$ in. by 2 $\frac{1}{2}$ in. by $\frac{1}{4}$ in. thick angles welded to the bottom chord of each main truss. The top of the bridging truss was welded to top chord of the main truss. All welds were $\frac{1}{4}$ in. fillets.

Three 2 in. by 3 in. steel deck support angles, one located 1 ft 8 $\frac{1}{16}$ in. from the north test frame edge, one at 8 ft 1 $\frac{5}{8}$ in. from the north test frame edge, and one at 6 ft $5\frac{5}{8}$ in. from the south test frame edge, were welded to the bottom of the top chord of the main truss (see Fig. 4–24).



Source: NIST.

Figure 4-24. Intersection of main truss and deck support angle.

At the intersection of the bridging trusses, steel deck support angles, and main trusses, a 3 in. by 3 in. by $\frac{3}{8}$ in. steel plate was welded to the top side of the bottom chord of the main truss with $\frac{1}{4}$ in. fillet on the east and west sides of the plate (see Fig. 4-25). There was no steel plate welded to the bottom chord at the location of the center steel deck support angle.



Source: NIST.

Figure 4-25. Intersection of main and bridging truss bottom chord.

Cover plates made from A36 steel, 7 in. wide and 0.116 in. thick, were welded to the full length of the top chords of the main trusses to prevent concrete from passing through (see Fig. 4–26). Steel cover plates measuring 3½ in. by 7 in. by 0.116 in. thick were welded under each web knuckle for the same purpose. A 6¼ in. length of No. 8 reinforcing steel rod was welded to each end stiffener at both ends of the truss.



Source: NIST.

Figure 4–26. Cover plate detail.

The steel floor deck was placed on the assembly in 3 ft 1½ in. widths, 18 ft lengths, with the crests and valleys parallel to the main trusses (Fig. 4–27). At the interface of the steel deck edge and the upper chords of the main trusses, the deck was secured to the chords with ½ in. puddle welds spaced 6 in. o.c.



Source: NIST.

Figure 4–27. Steel floor deck placement.

Chairs, $\frac{3}{4}$ in. high measuring 60 in. long, with 12 legs per chair spaced 5 in. o.c. and $2\frac{3}{4}$ in. from each end, were placed and taped on alternating deck crests along the full 17 ft length of the assembly (see Fig. 4–28). Welded wire fabric, 10 in. by 4 in. W4.2/W4.3, supplied in 60 in. widths, was placed on the chairs, with the 4 in. dimension running the length of the assembly (north to south). The wire fabric was notched to fit around the knuckles and instrumentation sleeves. Adjacent sections of WWF were overlapped nominal 12 in. per ACI 318-63 (ACI 1963). At the overlaps, the mesh was secured with 18 gauge wire twist-ties spaced approximately 24 in. o.c.



Source: NIST.

Figure 4–28. Chairs on steel deck.

No. 4 steel reinforcing bar was placed on top of the first layer of welded wire fabric, 3 in. from the east and west ends of the test frame. A second layer of welded wire fabric was installed with overlaps and fastened with wire ties as described above for the first layer. No. 5 steel reinforcing bar was placed on both sides of each bridging truss over the second layer of WWF (Fig. 4–29). The rebar was secured to the top layer of welded wire fabric with 18 gauge wire twist-ties approximately 24 in. o.c.



Source: NIST.

Figure 4–29. Welded wire fabric and rebar.

Concrete Placement

The ready-mixed concrete was poured to an average depth of 4 in. measured from the top plane of the 1½ in. deep steel deck. The concrete was finished to a flat, smooth surface with a wooden trowel. Details of the concrete for test Assemblies 3 and 4 are shown in Table 4–9.

Table 4–9. Details of concrete.

Assembly No.	Concrete Pour Date	Wet Unit Weight (lb/ft ³)	Slump(in.)	Air Content (%)	Water Added (gal)	Compressive Strength at 28 Days (psi)	Compressive Strength at 56 Days (psi)
3	2/20/2004	113.8	8	7	9	3370	3995
4	2/20/2004	111.6	7.5	8	0	2320	3220

Preparation of Trusses

Prior to the application of primer to the structural steel members, the steel was sand blasted to the Society of Protective Coatings SSPC-SP6 specification in accordance with the product specification sheet of the

primer. Following the sand blasting, the steel was primed with Sherwin Williams Type B50NV11 at an approximate dry film thickness of 0.003 in.

Instrumentation

Prior to the concrete pour, four 18-gauge Type K thermocouples were attached to the steel form deck at each of three locations, near the center point and quarter points in the north-south direction. At each location, a thermocouple was placed in the valley, sidewall, crest, and next adjacent valley of the deck. Refer to Appendix F for locations of deck thermocouples.

After priming of the structural steel, 18-gauge Type K thermocouples were installed on each main and bridging truss. Eight thermocouples were peened into the steel at each cross section, located approximately at the quarter and center points on each main truss (see Appendix F for exact locations). Additionally, ten thermocouples were located at the intersections of each main and bridging truss. In total, 44 thermocouples were installed on each main truss, for a total of 88 thermocouples.

On each bridging truss, four thermocouples were peened into the steel at each cross section located at the center of the truss, at the intersections of the main and bridging trusses, and approximately halfway between the main truss and the end of the bridging truss (see Appendix F for exact locations). In total, 16 thermocouples were installed on each bridging truss, for a total of 32 thermocouples.

Strain gauges were attached on the bottom chord of the main trusses to measure strain as each test assembly was loaded. A pre-wired 350 Ω resistance strain gauge was placed, per the manufacturer's instructions, on the top surface and bottom surface of the bottom chord angle. The strain gauges were symmetrically opposed, at the mid-length of the bottom chord of each main truss. Each pair of gauges would later be wired to a half-bridge amplifier prior to loading of the assembly. Strain gauge readings were used to confirm proper loading of the assemblies, and the circuitry was removed prior to the start of the tests.

Application of Sprayed Fire-Resistive Materials

The application of the sprayed fire resistive materials was conducted by the manufacturer of the sprayed fire resistive material under a sub-contract to UL and observed by representatives of UL and NIST. On the underside of the assembly, the BLAZE-SHIELD DC/F was applied to the main and bridging trusses in multiple coats. For Test Assembly No. 3, which had $\frac{3}{4}$ in. thick SFRM on the steel trusses, no attempt was made to control overspray on the metal deck. For Test Assembly No. 4, with $\frac{1}{2}$ in. thick SFRM, the metal deck was masked to prevent overspray.

Thickness and density measurements were taken in accordance with ASTM E 605 (ASTM 2000a). The average SFRM thicknesses on the trusses are shown in Table 4–10 for Test Assembly No. 3.

Table 4–10. SFRM Thickness measurements on Assembly No. 3.

Location	Nominal Thickness (in.)	Final Average Measured Thickness (in.)	Basis: No. of Thickness Measurements
East Main Truss	3/4	0.766	128
West Main Truss	3/4	0.763	128
North Bridging Truss	3/8	0.397	66
South Bridging Truss	3/8	0.387	66

The air dry density of the BLAZE-SHIELD DC/F sprayed fire resistive material was determined using twelve 12 in. by 12 in. samples of various thickness. The air dry densities are shown in Table 4–11 for Assembly No. 3. The average air dry density was found to be 20.49 pcf.

Table 4–11. Air dry density of spray applied fire resistive material on Assembly No. 3.

Material Type	Nominal Thickness (in.)	Measured Density (pcf)
DC/F	3/4	21.23
DC/F	3/4	19.76
DC/F	3/4	20.49

SFRM thickness measurements for Test Assembly No. 4 are given in Table 4–12. Air dry density of spray applied fire resistive material on Assembly No. 4 is given in Table 4–13, and the average air dry density was found to be 19.10 pcf. There was no sprayed fire resistive material applied to the bridging trusses on Assembly No. 4

Table 4–12. Thickness measurements on Assembly No. 4.

Location	Nominal Thickness (in.)	Final Average Measured Thickness (in.)	Basis: No. of Thickness Measurements
East Main Truss	1/2	0.514	128
West Main Truss	1/2	0.512	128

Table 4–13. Air dry density of spray applied fire resistive material on Assembly No. 4.

Material Type	Nominal Thickness (in.)	Measured Density (pcf)
DC/F	1/2	20.57
DC/F	1/2	18.90
DC/F	1/2	17.83

4.4 LOADING OF TEST ASSEMBLIES

The test assemblies were loaded in accordance with ASTM E 119. That is, a superimposed load was applied “to simulate a maximum load condition,” which was determined as “the maximum load condition allowed under nationally recognized structural design criteria” (ASTM 2000). In this section, the analysis for this maximum load condition is given, and the procedures used to apply the computed loads are explained for both the full- and reduced-scale test assemblies. The structural analysis and test loading procedure was performed by Wiss Janey Elstner & Associates (WJE) under sub-contract to Underwriters Laboratories Inc.

4.4.1 Loading of 35 Ft Assemblies

Table 4–14 details the demand-to-capacity ratio of key elements of the trusses for Assembly Nos. 1 and 2. Demand-to-capacity ratios for the original C32-T5 truss design are given in the last column and were computed from Laclede design calculation sheets (see Appendix G). The compression web diagonal at the vertical strut was the limiting member with a demand-to-capacity ratio of 1.01. The calculations indicate that the maximum load condition is achieved with a uniform load of 104 psf.

The test load was applied to the assembly in a sequence that generally proceeded outwards from the center. Concrete blocks, which had first been weighed, were placed between the truss lines starting at the midspan and working symmetrically to the east and west ends of the test assembly. Next, empty water tubs were placed symmetrically outward to the ends of the span, alternating between the truss lines from the midspan. Finally, concrete blocks were placed between the water tubs and the longitudinal edges of the assembly, again alternating along both edges, working symmetrically from midspan to the ends of the assembly. The last set of blocks was placed as close as practicable to the water tubs to minimize bending of the cantilevered deck slab. The water tubs were filled from the center of the assembly outward toward the edges. The amount of water was calculated for each location to insure the same load was applied at each section since the weight of the concrete blocks varied slightly.

Table 4–14. Summary of analysis for maximum load condition for 35 ft assembly.

Test Assembly		35 Foot	Laclede WTC Design
Load Case		Uniform Load	Calculations
Uniform Self Weight Construction Load (psf)		48	46
Additional Superimposed Load (psf)		104*	108
Top Chord Panel Point	Truss Member	Member DCR	Member DCR
A: Short End of truss			
B: Bearing point			
	#5: End Diagonal at short end	0.50	0.58**
	#2A: Vertical at short end	0.85	NA***
C: At vertical strut			0.97
	#4: Compression web diagonal	1.01	
D:			NA***
	#4A: Compression web diagonal	0.76	
E: At bridging Truss			
F:			
G: Near midspan			
H:			
J: At bridging Truss			
	#3A: Compression web diagonal	0.65	NA***
K:			
	#3: Compression web diagonal	0.97	0.99
L: At vertical strut			
	#2: Vertical at long end	0.87	1.00
	#1: End diagonal at long end	0.88	0.99
M: Bearing point			
N: Long end of truss			
Bottom Chord	#7: Tension chord near midspan	0.63	0.81

* Includes 2 psf representing weight of SFRM

** The original Laclede calculations use a slope factor of 1.90, whereas the slope factor for Member 5 should be on the order of 1.45 according to truss geometry. The original Laclede DCR of 0.76 has been adjusted as follows: $0.76 * 1.45 / 1.90 = 0.58$

*** Not Applicable: The Laclede calculations do not include a design for this member.

4.4.2 Loading of 17 Ft Assemblies

Table 4–15 details the demand-to-capacity ratio of key elements of the trusses for Assembly Nos. 3 and 4. The long end web diagonal at the vertical strut was the limiting member with a demand-to-capacity ratio of 1.00. The calculations indicate that the maximum load condition is achieved with a uniform load of 293 psf and concentrated loads applied at the truss panel points averaging to 86 psf.

Table 4–15. Summary of analysis for maximum load condition for 17 ft assembly.

Test Assembly		17 Foot			Laclede WTC Design
Load Case		Uniform Load	Concentrated Load		Calculations
Uniform Self Weight Construction Load (psf)		48	48		46
Additional Superimposed Load (psf)		293	86*		108
Top Chord Panel Point	Truss Member	Member DCR	Load(lbs)	Member DCR	Member DCR
A: Short End of truss					
B: Bearing point					
	#5: End Diagonal at short end	0.58		0.58	0.58**
	#2A: Vertical at short end	0.60		0.60	NA***
C: At vertical strut			4100		0.97
	#4: Compression web diagonal	0.46		0.38	
D:			0		NA***
	#4A: Compression web diagonal	0.34		0.34	
E: At bridging Truss			4100		
F:			0		
G: Near midspan			4100		
H:			0		
J: At bridging Truss			3800		
	#3A: Compression web diagonal	0.35		0.37	NA***
K:			0		
	#3: Compression web diagonal	0.53		0.43	0.99
L: At vertical strut			3800		
	#2: Vertical at long end	0.55		0.55	1.00
	#1: End diagonal at long end	1.00		1.00	0.99
M: Bearing point					
N: Long end of truss					
Bottom Chord	#7: Tension chord near midspan	0.70		0.64	0.81

*Includes 2 psf representing weight of SFRM

** The original Laclede calculations use a slope factor of 1.90, whereas the slope factor for Member 5 should be on the order of 1.45 according to truss geometry. The original Laclede DCR of 0.76 has been adjusted as follows: $0.76 * 1.45 / 1.90 = 0.58$

*** Not Applicable: The Laclede calculations do not include a design for this member.

The test load was applied to the assembly in a sequence that generally proceeded outward from the center of the deck. First, empty water tubs were placed between the truss lines, starting at midspan and working symmetrically to the ends of the span. Next concrete blocks were placed, working both truss lines simultaneously from mid-span symmetrically outward to the ends of the span. After the concrete blocks were placed, the water tubs were filled to calculated depth. The hydraulic ram loads were applied last using four electric driven hydraulic pumps with pressure gauges.

4.5 INSTRUMENTATION

Prior to testing of each assembly, instrumentation was installed to measure vertical deflections of the unexposed surface and the bottom chords of the main trusses. Instruments were also added to characterize the furnace environment as well as to measure temperature on the unexposed surface of the test assembly.

4.5.1 Deflection Instrumentation

The deflection on the unexposed surface was measured using nine transducers, located approximately at the center and quarter points in the long span direction and center and quarter points in the short span direction. The locations of the deflection transducers are given in Appendix D for the 35 ft test assemblies and Appendix F for the 17 ft test assemblies.

The deflection of the bottom chord of the main truss was measured at six locations by means of thin round bars, welded at one end to the bottom chord of the main truss and protruding through sleeves in the concrete slab. Displacement transducers were attached to the rods and to a stationary frame. To account for any thermal expansion of the round bar, 20 gauge Inconel thermocouples were attached approximately at the midpoint of the depth of the main truss to measure temperatures throughout the duration of the test.

4.5.2 Furnace Thermocouples

The furnace temperature at UL's Toronto fire test facility was measured by means of twenty-four, 16 gauge Type K thermocouples, sheathed in Inconel pipe symmetrically located in the furnace chamber. Sixteen furnace thermocouples, made from similar materials, were used at UL's Northbrook furnace. In addition to the furnace thermocouples required by the ASTM E 119 Standard, Wickstrom plate thermocouples and aspirated thermocouples were located at the level of the bottom chord of the main truss and at the valley of the steel form deck. The locations of the aspirated and plate thermocouples are given in Appendix D for the 35 ft test assemblies and Appendix F for the 17 ft test assemblies..

The Wickstrom plate thermocouples were made of a stainless steel sheet, on which an 18 gauge Type K, Inconel sheathed thermocouple was attached to the back side. An insulating pad, approximately 4 in. by 4 in. by ¼ in. was placed over the thermocouple. The non-insulated stainless steel side was positioned horizontally, receiving a furnace exposure similar to the tested assembly.

The double walled aspirated thermocouple consisted of two concentric stainless steel tubes, approximately 0.435 in. ID and 0.1875 in. ID, with an 18 gauge Type K thermocouple bead located approximately ⅛ in. inside the end of the center tube. Furnace gasses were drawn through both tubes past

the thermocouple bead using a Venturi air amplifier. At room temperature, air was measured at approximately 30 ft/s at the tip of the concentric tubes.

4.5.3 Radiometers

To also characterize the furnace environment, both Gardon Gauge and Schmidt-Boelter types of heat flux gauges were mounted to the assembly (see Fig. 4–30). Table 4–16 summarizes the type of radiometer gauges used for each test.

Table 4–16. Summary of radiometers.

Assembly No.	Location	Type: Gardon Gauge (GG) or Schmidt-Boelter (SB)
1	Bottom Chord	SB
	Deck	SB
2	Bottom Chord	– *
	Deck	– *
3	Bottom Chord	GG
	Deck	GG
4	Bottom Chord	GG
	Deck	SB

* Due to significant damage to the heat flux probes during testing of Assembly 1, no heat flux probes were available at the time when testing Assembly 2

Similar to the plate and aspirated thermocouples, the heat flux probes were placed at two locations in the furnace: at the bottom chord level of the main trusses and at the valley of the steel deck. The locations of the sensors are given in Appendix D for the 35 ft test assemblies and Appendix F for the 17 ft test assemblies.

The Schmidt-Boelter radiometers were 1 in. diameter, 4 ft long, water and air cooled furnace probes with Schmidt-Boelter heat flux sensors. The sensors were capable of measuring heat fluxes up to 25 BTU/ft²-s (284 kW/m²) and had a view angle of 150 degrees. An air purged zinc selenide window was attached to the sensor, blocking convective flux, thus the sensor measured only radiative flux.

Gardon Gauge sensors, used in two of the tests, were 1 in. diameter, internally water cooled, with the wire leads air purged and insulated. The sensors were capable of measuring heat fluxes up to 15 BTU/ft²-s (170 kW/m²) and had a view angle of 180 degrees. No window was attached to the sensor, thus total (radiative and convective) heat flux was measured.



Source: NIST.

Figure 4–30. View of radiometer and plate thermocouple.

Chapter 5 TEST RESULTS

The tests described herein were conducted in accordance with the Standard Test Methods for Fire Tests of Building Construction and Materials, ASTM E 119-2000a. Results of all four fire resistance tests are presented in this chapter; each test is discussed separately.

5.1 FIRE TEST OF ASSEMBLY NO. 1

The fire resistance test of Assembly No. 1 was conducted at Underwriter Laboratories Toronto, Canada facility (ULC) on August 7, 2004 under the observation of representatives of Underwriters Laboratories Inc., Underwriters' Laboratories of Canada, and NIST.

The relative humidity of the concrete slab met the requirements prescribed in ASTM E 119.

5.1.1 Test Observations

Table 5–1 presents observations that were recorded during the conduct of the test. All dimensions given are approximate since they were estimated by making observations through furnace viewports. Times were generally recorded to the nearest minute. The term “report” is used to describe a loud sound, which might be described as a “bang” or a “pop.” Because these loud reports were often accompanied by observed movement of the metal deck and the dislodging of SFRM, it is assumed that the reports signaled explosive spalling of the concrete. It was not possible to ascertain the exact location and extent of any spalling.

Table 5–1. Test observations – Assembly 1.

Test Time, Min	Exposed (E) or Unexposed (U) Surface	Observations
0.5	E	There was slight discoloration of the SFRM on the west side of the assembly.
7	E	The east center steel deck seam began to separate.
11	E	The deck buckled west of the west bridging truss running in a north-south direction.
14	E	The east steel deck seam had a 3/8 in. opening
16		The vertical member on the east bridging truss where it intersects the south main truss had buckled.
17	E/U	Reports heard with the SFRM deck over-spray falling simultaneously.
19	E/U	Same observation as 17 minutes.
19	E	The east steel deck seam had a 5/8 in. opening
20	E/U	Same observation as 17 minutes and could visually see deck moving simultaneously.
21	E/U	Reports becoming louder and more frequent.
21	U	The concrete was spalling near the west end of the assembly.

Test Time, Min	Exposed (E) or Unexposed (U) Surface	Observations
23	E/U	Same observation as 21 minutes.
24	U	The concrete continued to spall.
25	E	Visual deflection was observed in the bottom chords of the bridging trusses.
26	E/U	Same observation as 21 minutes.
26	E	Visual deflection was observed on the deck spans between the trusses. Separation was observed in the deck seam above the center deck support angle.
27	E	The southeast metal deck seams began to separate.
29	E	Visual deflection was observed in the center deck support angle. The SFRM was turning brown in color.
33	E	The bridging trusses became more deformed. The vertical member on the west bridging truss where it intersects the south main truss was heavily deformed.
37	E	The deflection in the center deck support angle was more pronounced.
38	E/U	Reports heard.
44	E	The vertical members on all of the bridging trusses where they intersect the main trusses were deformed.
45	E	Large reports heard.
49	E/U	A loud report was heard near the center of assembly and a visible drop was observed.
53	E	One-half of the SFRM on the vertical member noted at 33 min. had fallen.
60	E	No additional fall off of SFRM on the bridging trusses.
63	E	The steel deck between west bridging truss and the deck support angle was 1/2 in. from the furnace thermocouple. The long diagonal web member on the south main truss was slightly bent.
68	E/U	Large report heard.
78	E/U	Large report heard.
78	E	The bottom chord of the north main truss, approximately 36 in. west of the assembly centerline, was deformed.
87	E	A 10 in. long piece of SFRM on the inner most angle of the lower chord on the north truss, 36 in west of the north-south centerline of the assembly fell.
88	E	A 7 to 10 in. long piece of SFRM on the inner most angle of the lower chord on the north truss, 36 in east of the north-south centerline of the assembly fell.
90	E	Additional SFRM at the area described at 87 min. peeling away but has not fallen.
92	E	A 12 in. long piece of SFRM on the inner most angle of the lower chord on the south truss, 36 in west of the north-south centerline of the assembly fell.
93	E	The area of fall off described at 87 min. had expanded to the three inner most angles.
109	E/U	A very large report was heard.
111	E/U	A very large report was heard.
116	E/U	Gas off, furnace fire extinguished.

5.1.2 Data

All data shown in the following figures (Figures 5–1 through 5–12) are unedited for the entire duration of the test. However, not all data shown is reliable due to the limitations of the instrumentation, i.e. thermocouples, radiometers, and calorimeters. Data may become unreliable past the rating period when structural events occur that can dislodge the instrumentation. Also, protective insulation of the thermocouple wire may burn away, and the individual wires can make contact with themselves and/or neighboring wires rendering the data unreliable. Appendix H gives a listing of the times that various instrumentation failed to give reliable data, as determined by UL.

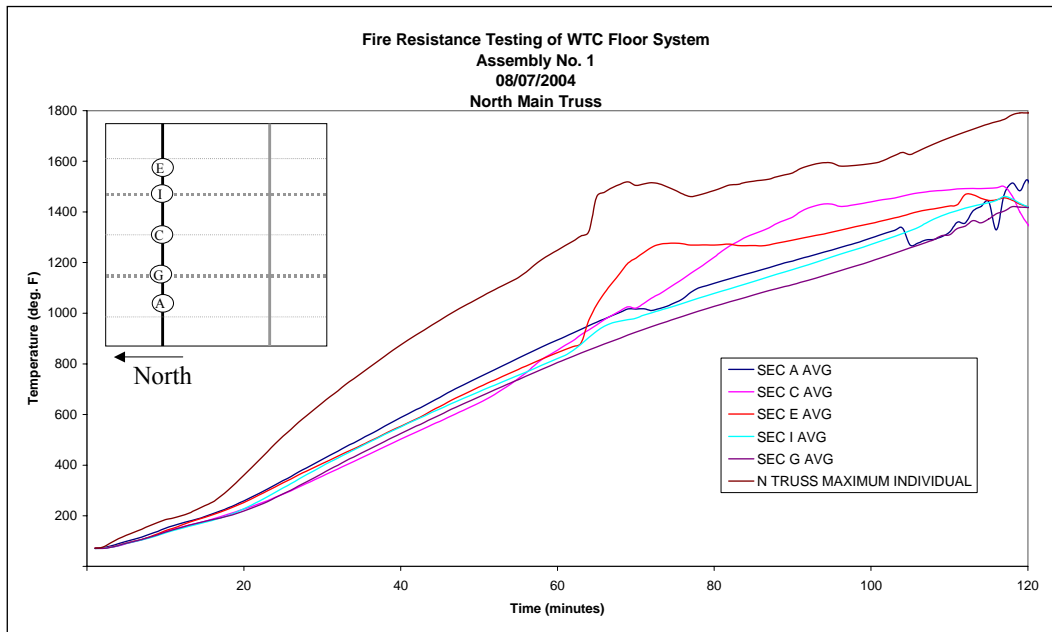

Figure 5–1. Assembly No. 1 – average and maximum individual temperatures on north main truss.

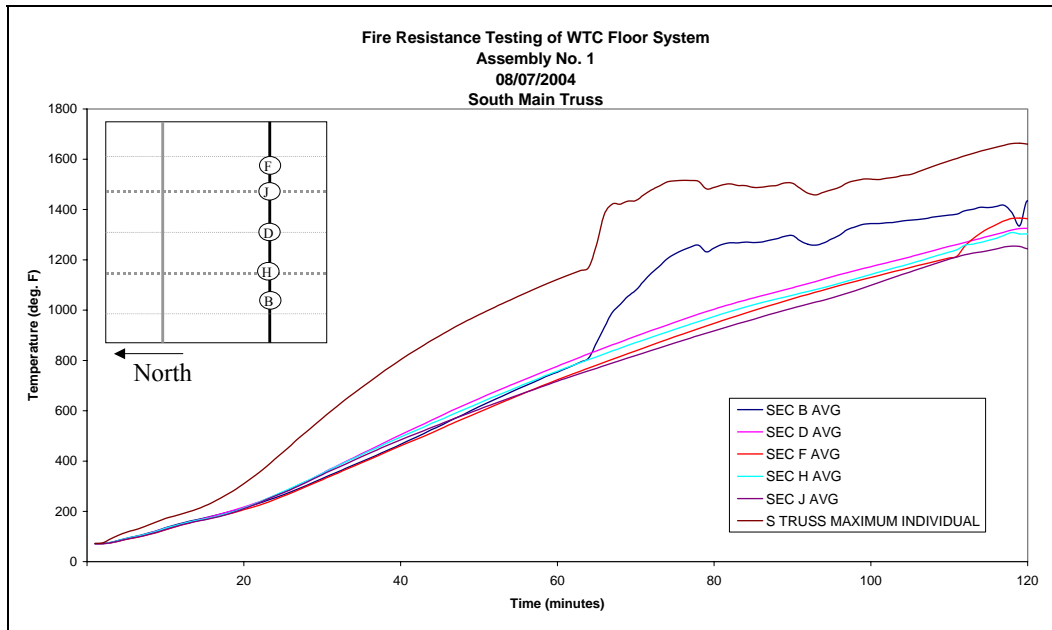

Figure 5–2. Assembly No. 1 – average and maximum individual temperatures on south main truss.

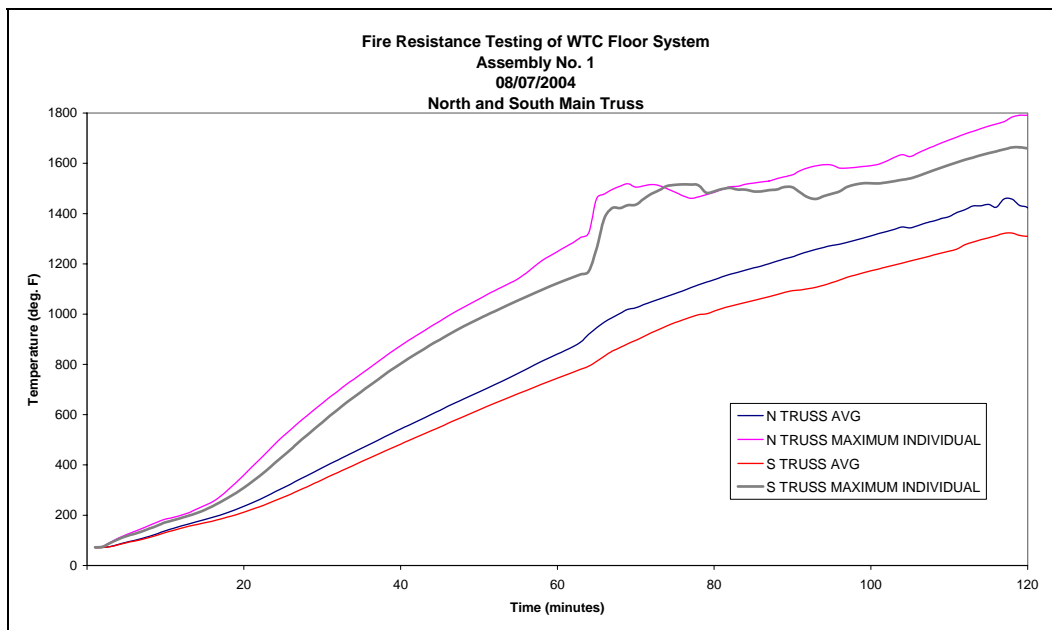

Figure 5–3. Assembly No. 1 – overall average and maximum individual temperatures on north and south main trusses.

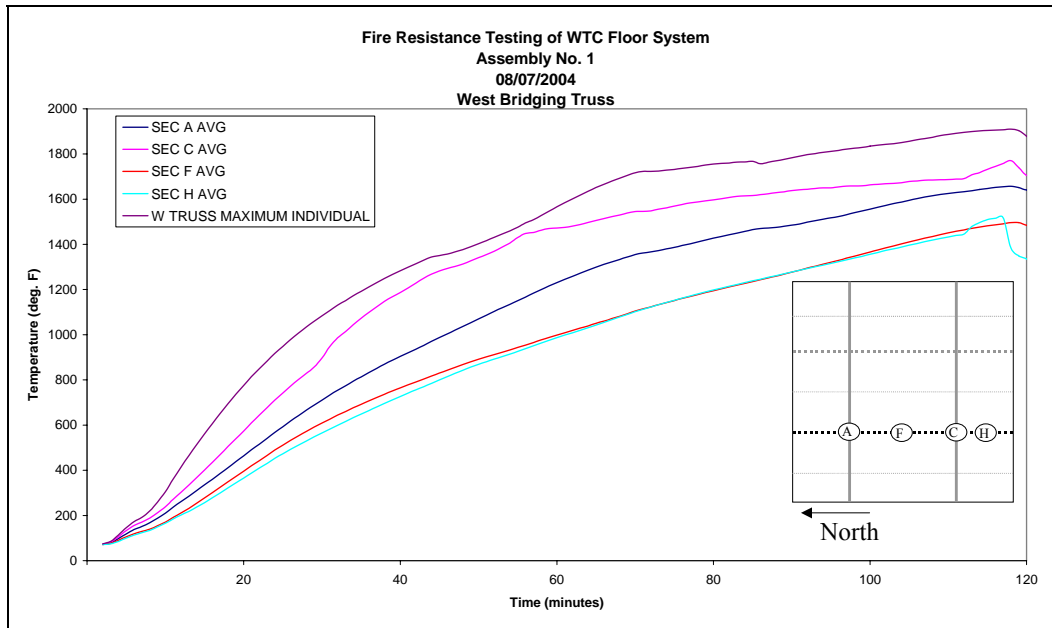

Figure 5-4. Assembly No. 1 – average and maximum individual temperatures on west bridging truss.

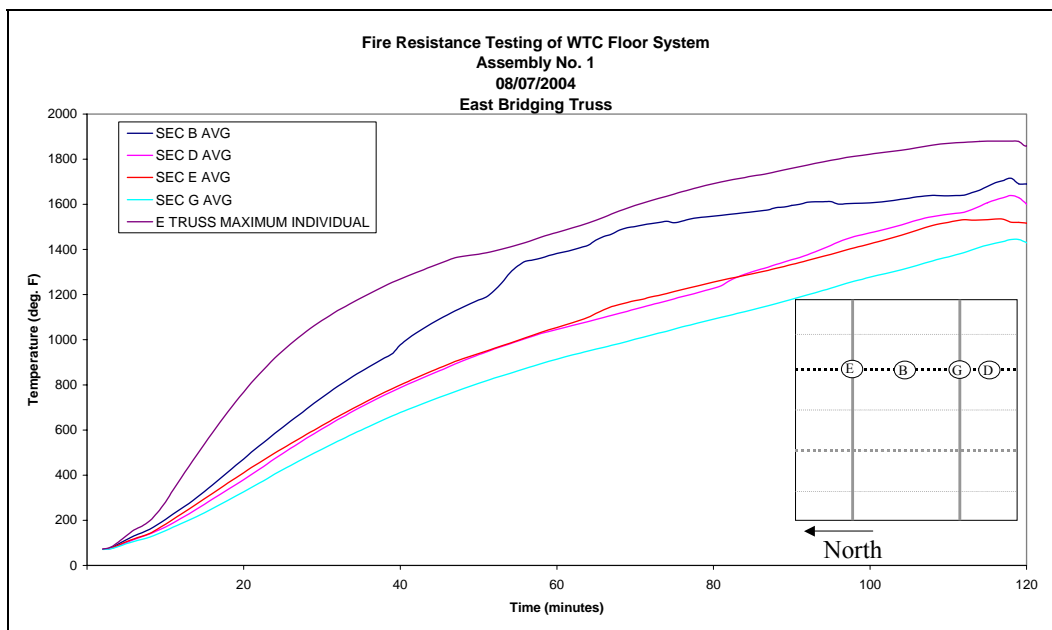

Figure 5-5. Assembly No. 1 – average and maximum individual temperatures on east bridging truss.

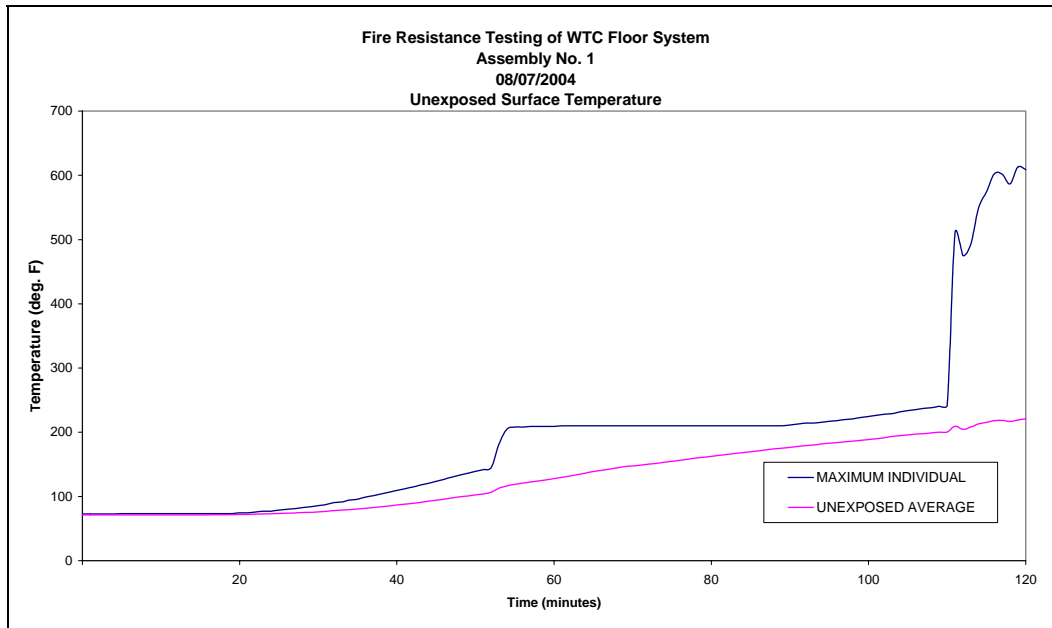

Figure 5-6. Assembly No. 1 – average and maximum individual temperatures on unexposed surface.

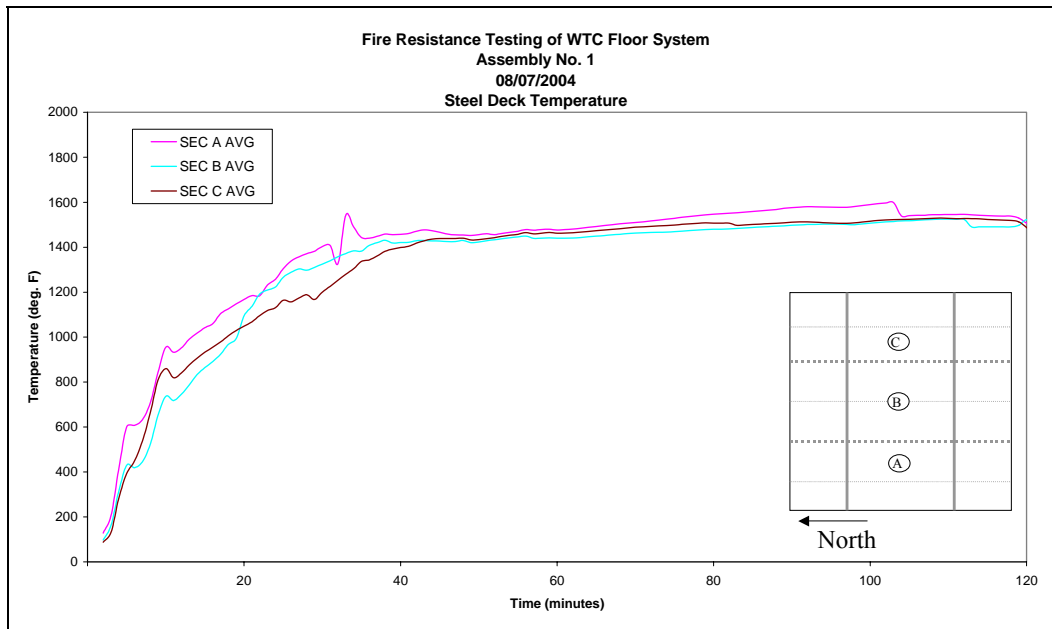

Figure 5-7. Assembly No. 1 – average temperatures on steel deck.

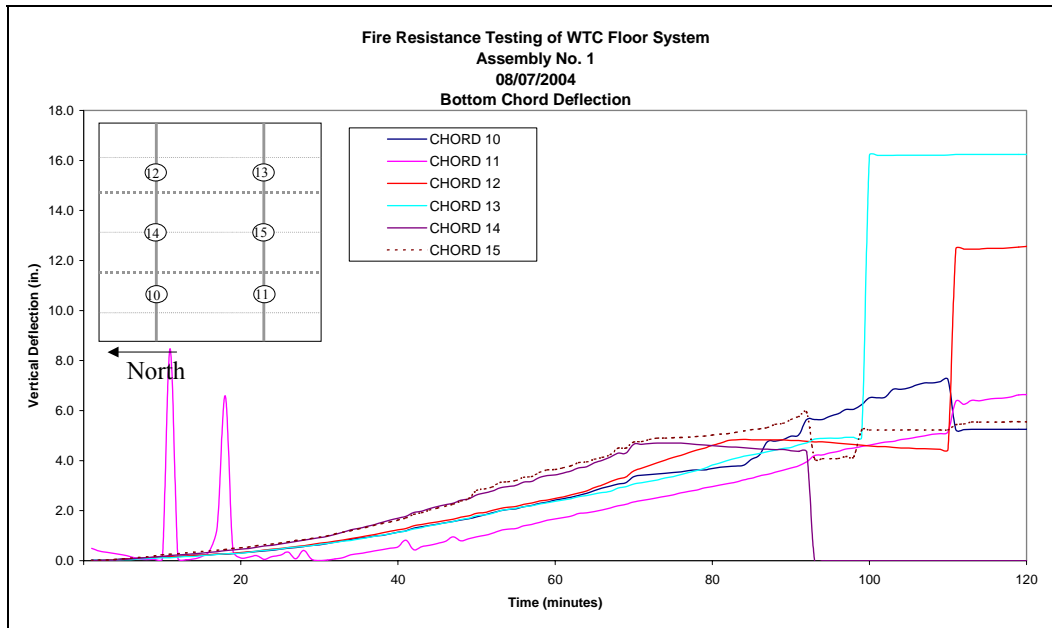

Figure 5–8. Assembly No. 1 – bottom chord deflection measurements.

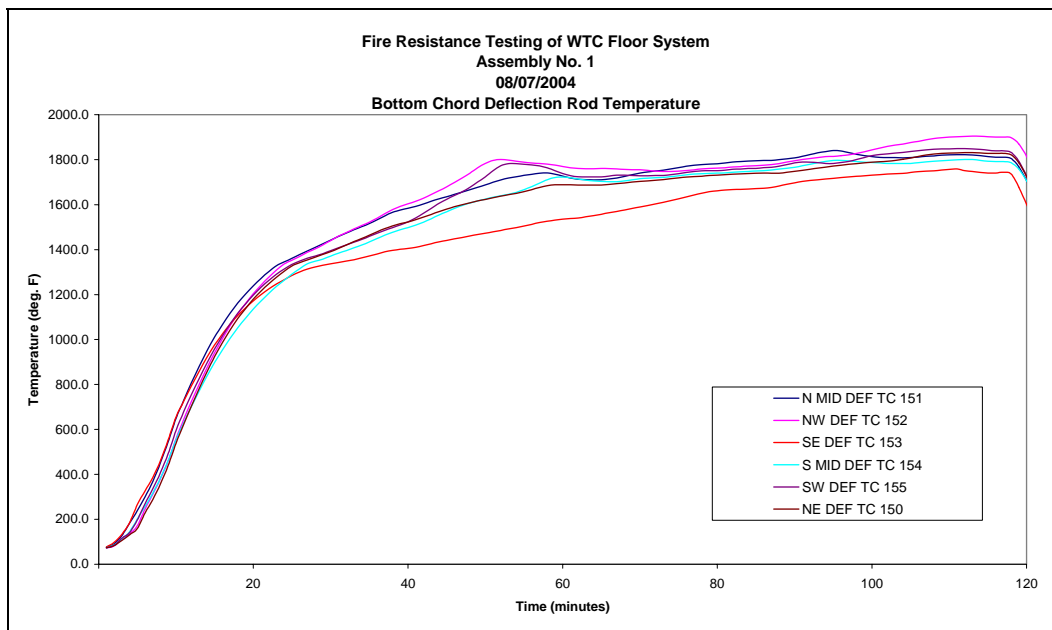

Figure 5–9. Assembly No. 1 – temperatures of bottom chord deflection rods.

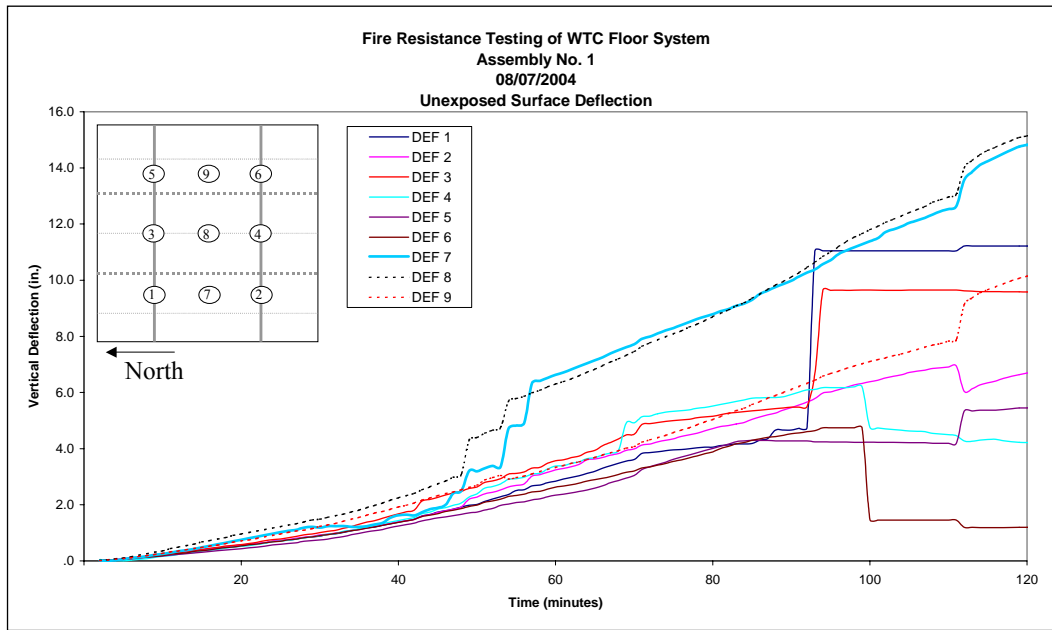

Figure 5–10. Assembly No. 1 – unexposed surface deflection measurements.

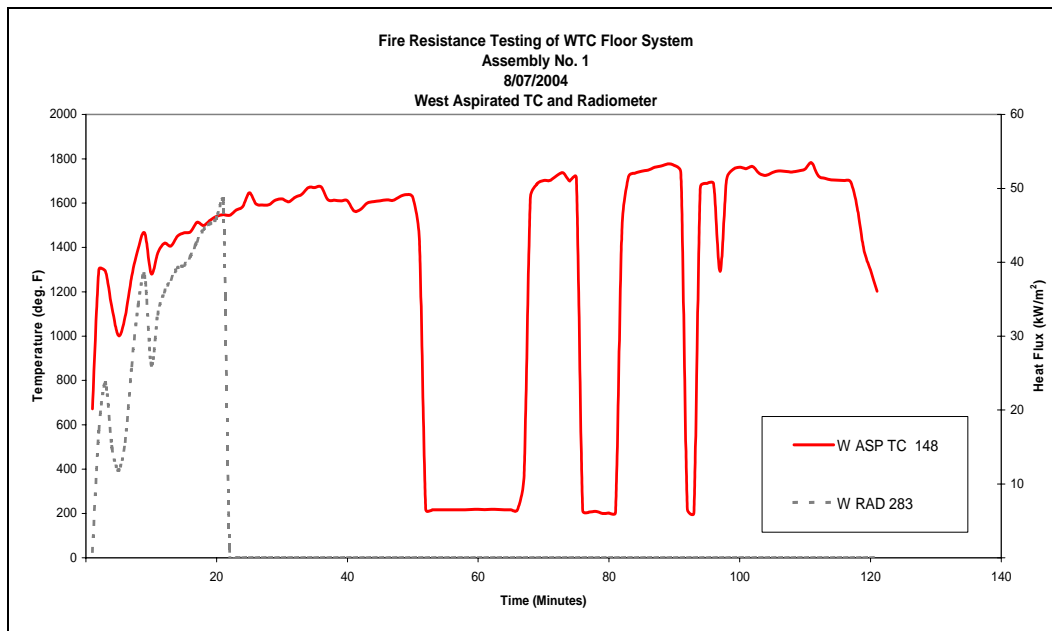

Figure 5–11. Assembly No. 1 – additional instrumentation through west opening.

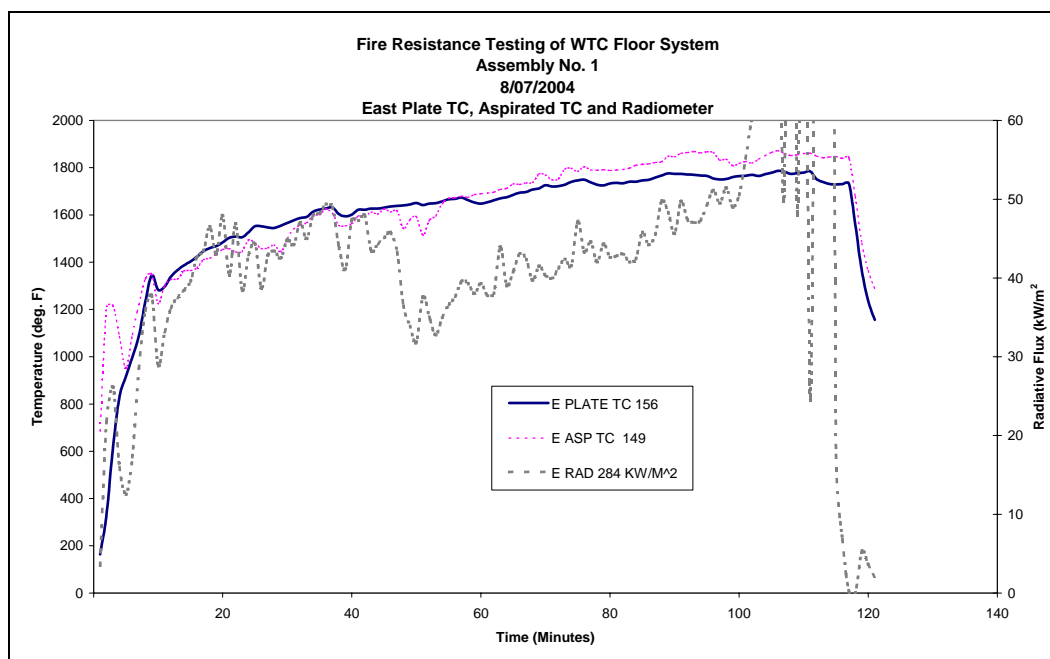
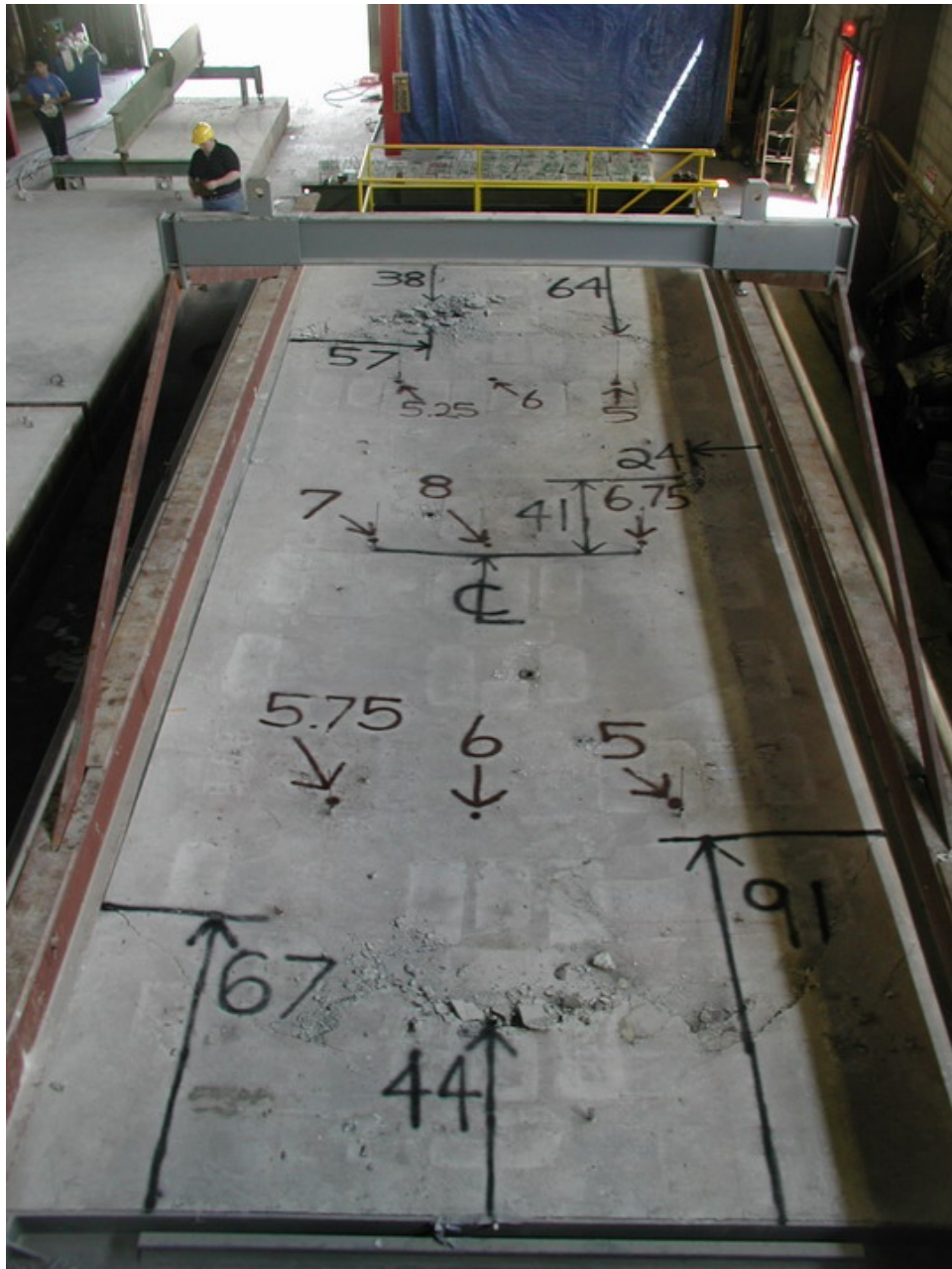

Figure 5–12. Assembly No. 1 – additional instrumentation through east opening.

5.1.3 Post-Test Observations

Figure 5–13 shows the unexposed surface of the assembly after all loading equipment had been removed (view looking east). Numbers shown at the centerline and quarter points are vertical deflections after cooling. All other numbers are reference dimensions as measured from the edge of the slab.

Figures 5–14 through 5–19 are additional views of the top of the specimen, showing the cracked and spalled concrete, and of the underside, showing bulging of the metal deck and deformations of the steel trusses after the test specimen had cooled and had been removed from the furnace. To confirm the spalling of the bottom side of the concrete slab and to quantify the depth of spalling, sections of the slab were cut using a diamond concrete wet saw (see Fig. 5–20). The depth of the delamination spalling varied but was on the order of 2 in. as seen in Fig. 5–21.



Source: NIST.

Figure 5–13. Unexposed surface of Assembly No. 1 after loading equipment was removed.

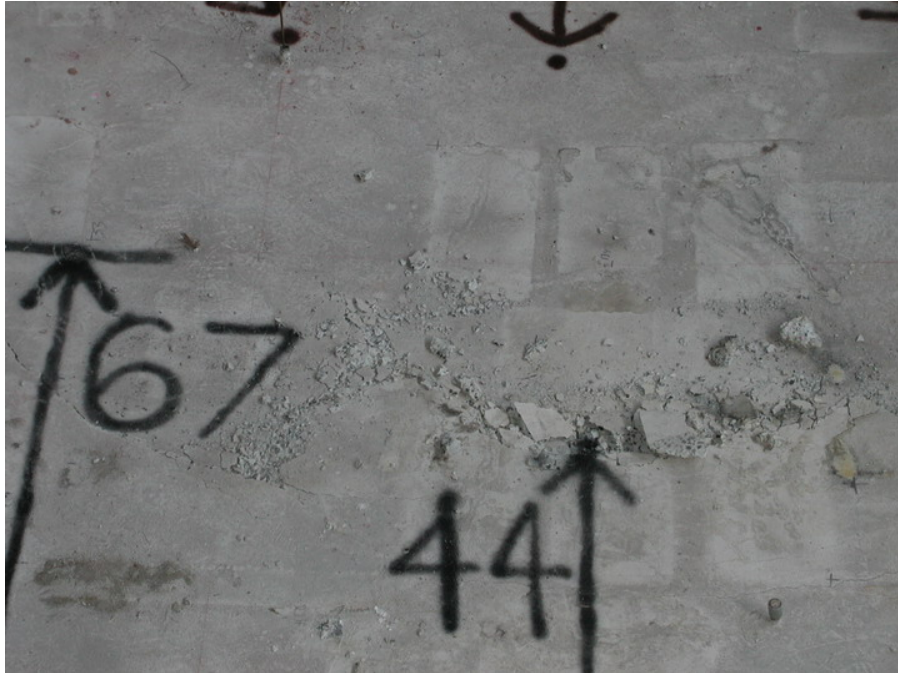

Source: NIST.

Figure 5–14. Detail of spalling concrete at west end of Assembly No. 1.



Source: NIST.

Figure 5–15. Detail of spalling concrete at east end of Assembly No. 1.



Source: NIST.

Figure 5–16. Close-up of spalling concrete at east end of Assembly No. 1.



Source: NIST.

Figure 5–17. View looking east of the exposed side of Assembly No. 1—south main truss seen at right side.



Source: NIST.

Figure 5–18. Intersection of north main and east bridging trusses on Assembly No. 1.



Source: NIST.

Figure 5–19. View of core-end diagonal strut of south main truss on Assembly No. 1.



Source: NIST.

Figure 5–20. Sections cut through concrete slab to confirm delamination spalling.

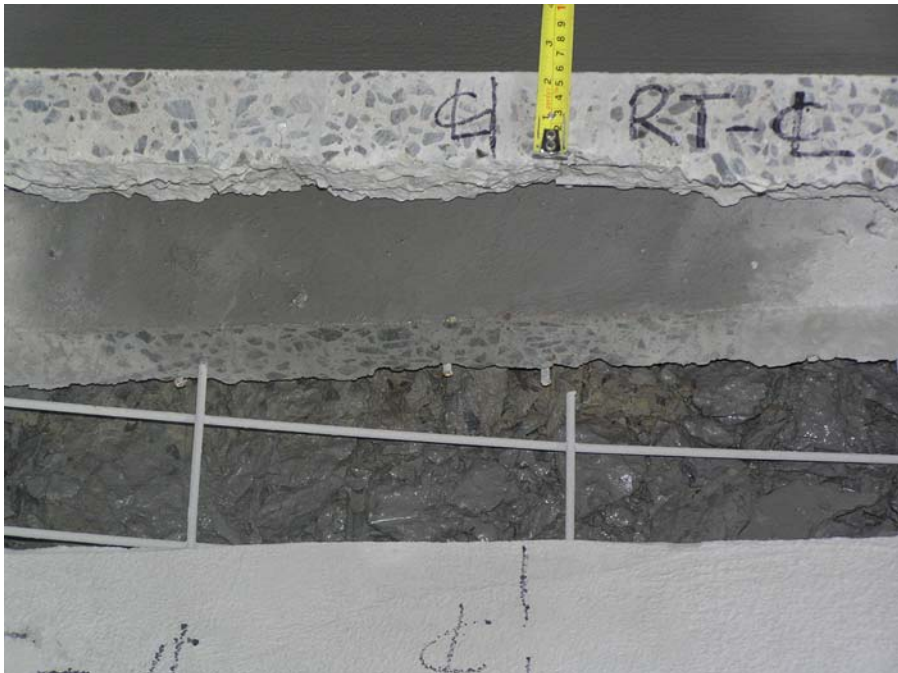

Source: NIST.

Figure 5–21. Measurement of depth of delamination spalling.

5.2 FIRE TEST OF ASSEMBLY NO. 2

The fire resistance test of Assembly No. 2 was conducted at the (ULC) facility on August 11, 2004 under the observation of representatives of Underwriters Laboratories Inc., Underwriters Laboratories of Canada, NIST, and a member of the National Construction Safety Team Advisory Committee.

The relative humidity of the concrete slab met the requirements prescribed in ASTM E 119.

5.2.1 Test Observations

Table 5–2 presents observations that were recorded during the conduct of the test. All dimensions given are approximate since they were estimated by making observations through furnace viewports. Times were generally recorded to the nearest one half minute. The term “report” is used to describe a loud sound, which might be described as a “bang” or a “pop.” Because these loud reports were often accompanied by observed movement of the metal deck and the dislodging of SFRM, it is assumed that the reports signaled explosive spalling of the concrete. It was not possible to ascertain the exact location and extent of any spalling. The reports heard during the test of Assembly No. 2 were generally not as loud as those heard during the test of Assembly No. 1.

Table 5–2. Test observations – Assembly No. 2.

Test Time, min	Exposed (E) or Unexposed (U) Surface	Observations
1	E & U	Faint reports heard.
1	E	The SFRM began to discolor.
3	E & U	A faint report was heard.
3	E	SFRM over-spray on the steel deck began to fall when report was heard.
5	E	The steel deck began to deform east of the east bridging truss and west of the west bridging truss.
10	E	A buckle in the steel deck was observed. The buckle was located 1 ft west of the center deck support angle and ran in a north–south direction. The length of the buckle spanned from the north truss to the south truss.
12	E	The steel deck was bowing downward between the bridging trusses and the center deck support angle.
15	E & U	A faint report was heard.
16	E & U	A faint report was heard.
18	E & U	Reports became slightly louder. There were three reports in a row, approx. 5 seconds apart.
22	E & U	Reports continued and became slightly louder.
22	E	There was minor fall off of the SFRM on the top angle of the east bridging truss. The fall off was partial and did not result in bare steel being exposed.
23	E & U	Reports continued.
30	E & U	Reports continued.
34	E	Visual deformation of the top angles of bridging trusses was observed.
36	E	There was no visual buckling of the bridging truss web members.

Test Time, min	Exposed (E) or Unexposed (U) Surface	Observations
40	E & U	A large report was heard. Pronounced deck bow at the area noted in the 10 min. observation.
43	E	The web members of the bridging trusses began to deform.
46	E	The steel deck continued to deform.
48	E & U	Reports continued.
48.5	E & U	A report was heard.
50	E & U	A report was heard.
51.5	E & U	A report was heard.
53	E	Visual deflection of the center deck support angle was observed.
54	E & U	A report was heard.
56.5	E & U	A report was heard.
57	E & U	Three reports in a row were heard, approx. 1 second apart.
59.5	E & U	A report was heard.
60	E	All SFRM remained in place besides what was previously noted on the bridging trusses.
61	E & U	A report was heard.
63	E & U	A report was heard.
64	E & U	A report was heard.
72	E & U	A report was heard.
74	E	2 1/2 ft length of SFRM fell from the top angle of the east bridging truss.
75	E & U	A report was heard.
78	E & U	A report was heard.
84	E & U	A report was heard.
108	E	All SFRM remained on the main trusses.
120	E	All SFRM remained on the main trusses.
130	E & U	All observations were terminated due to safety precautions.
146	E & U	Gas off, fire test terminated.

5.2.2 Data

All data shown in the following figures (Figures 5–22 through 5–33) are unedited for the entire duration of the test. However, not all of the data shown is reliable due to the limitations of the instrumentation, i.e. thermocouples, radiometers, and calorimeters. Data may become unreliable past the rating period when structural events occur that can dislodge the instrumentation. Also, protective insulation of the thermocouple wire may burn away, and the individual wires make contact with themselves and/or neighboring wires rendering the data unreliable. Appendix H gives a listing of the times that instrumentation failed to give reliable data, as determined by UL.

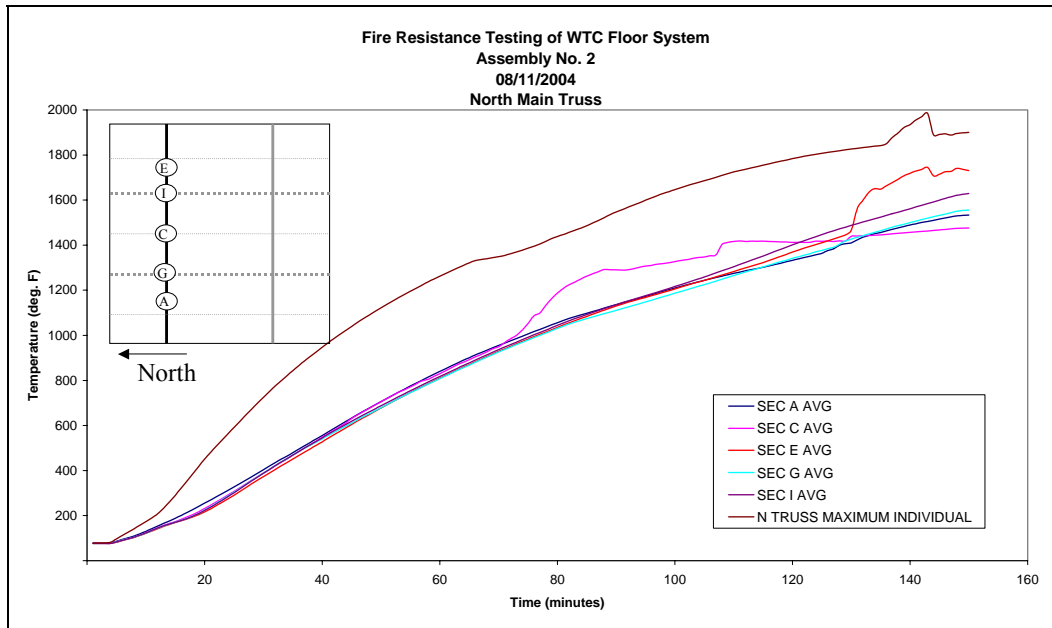

Figure 5-22. Assembly No. 2 – average and maximum individual temperatures on north main truss.

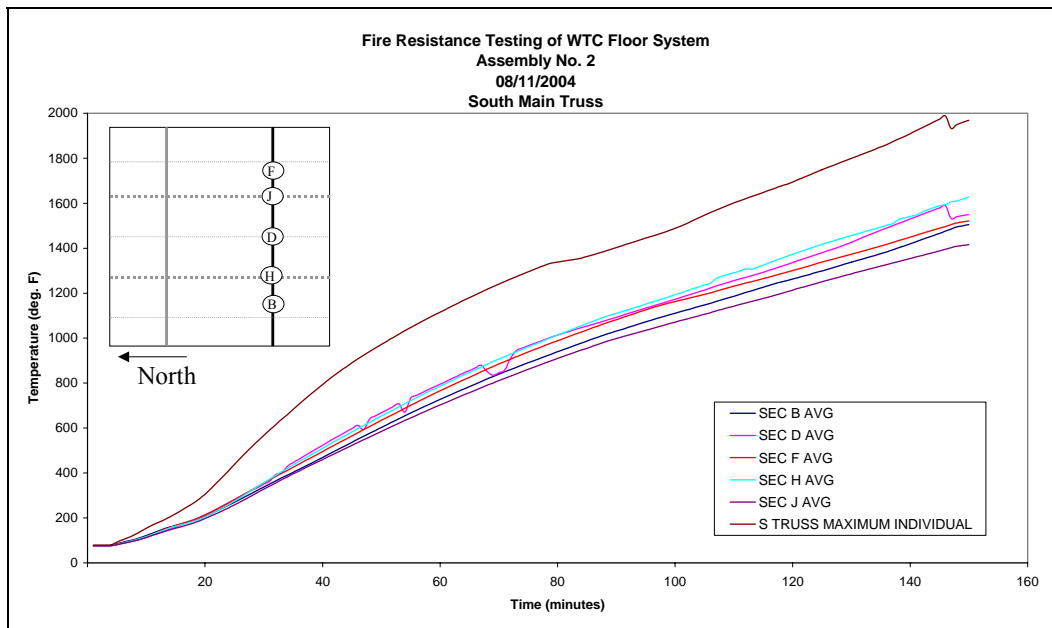

Figure 5-23. Assembly No. 2 – average and maximum individual temperatures on south main truss.

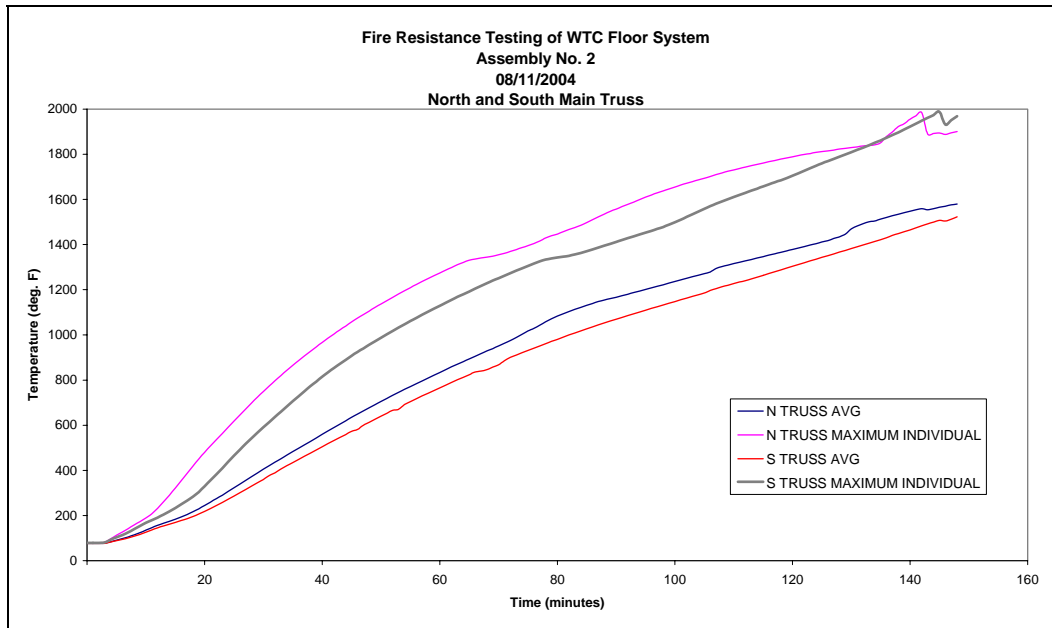

Figure 5–24. Assembly No. 2 – overall average and maximum individual temperatures on north and south main trusses.

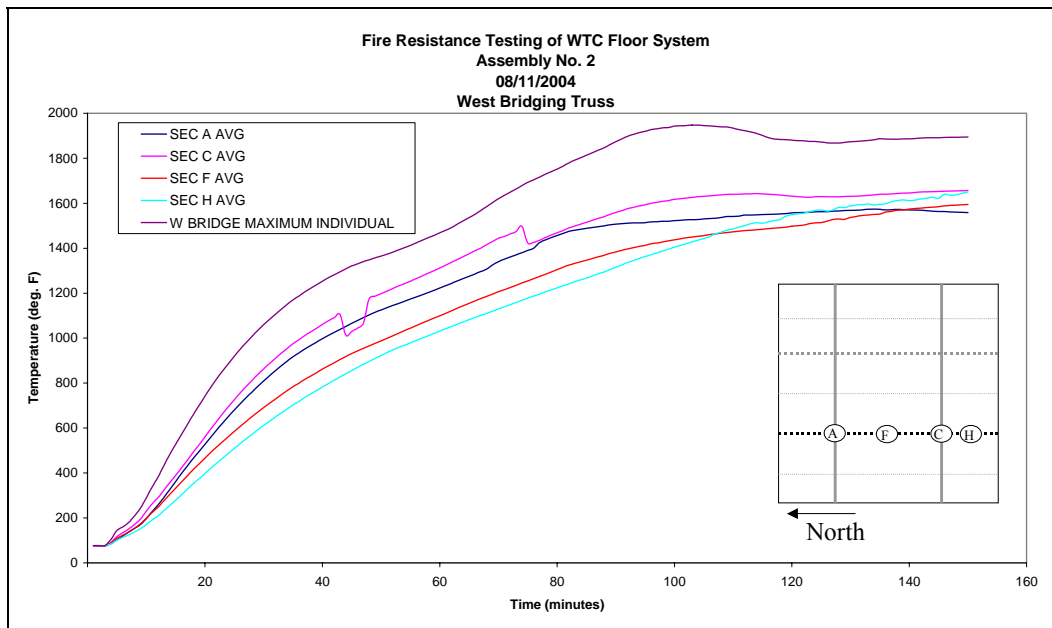

Figure 5–25. Assembly No. 2 – average and maximum individual temperatures on west bridging truss.

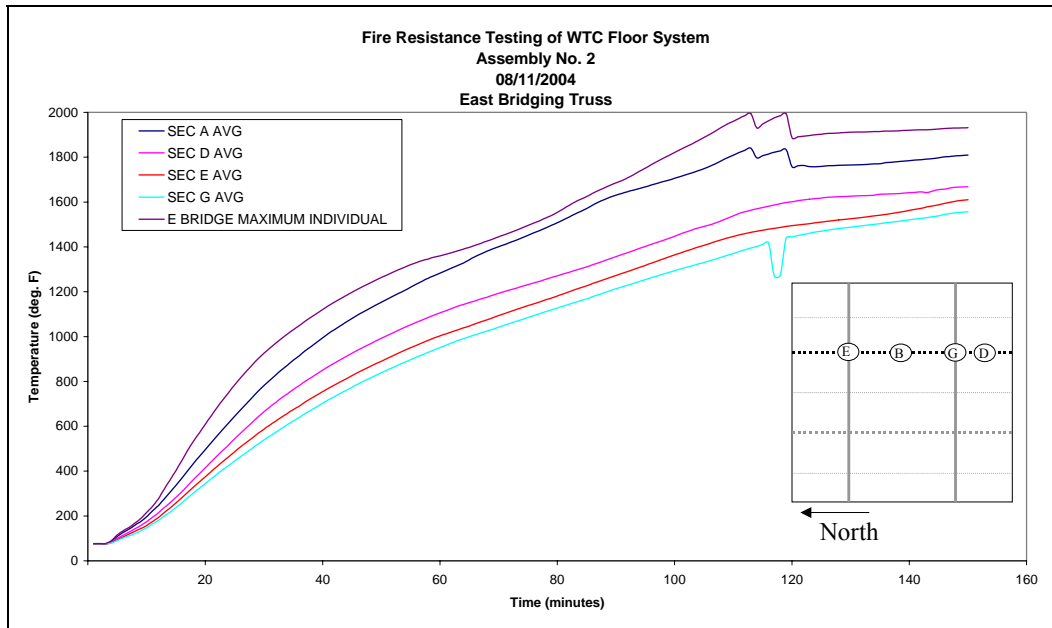

Figure 5–26. Assembly No. 2 – average and maximum individual temperatures on east bridging truss.

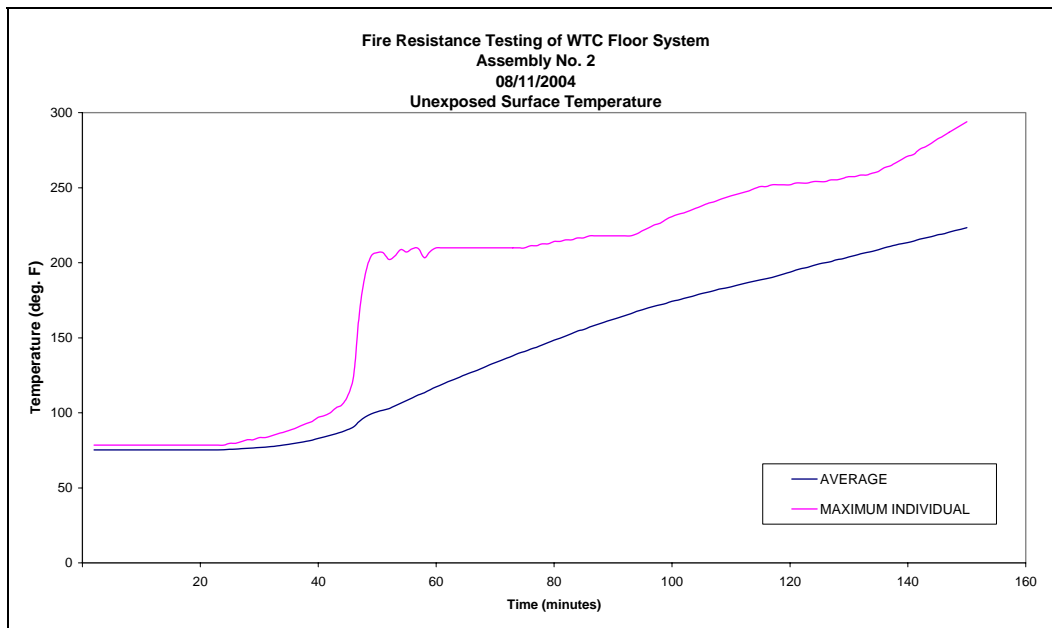

Figure 5–27. Assembly No. 2 – average and maximum individual temperatures on unexposed surface.

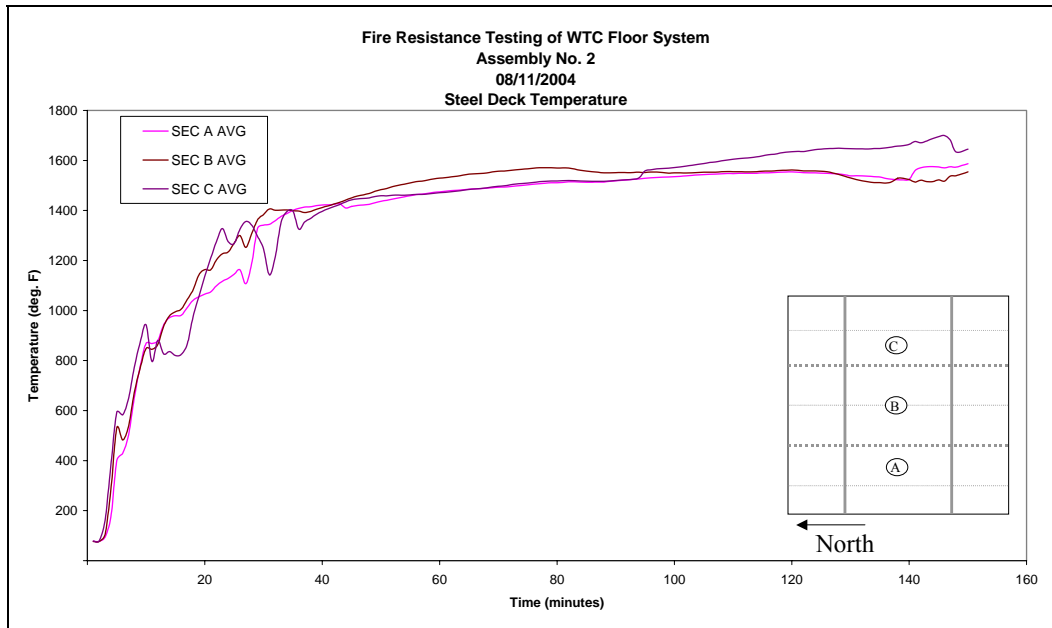

Figure 5–28. Assembly No. 2 – average temperatures on steel deck.

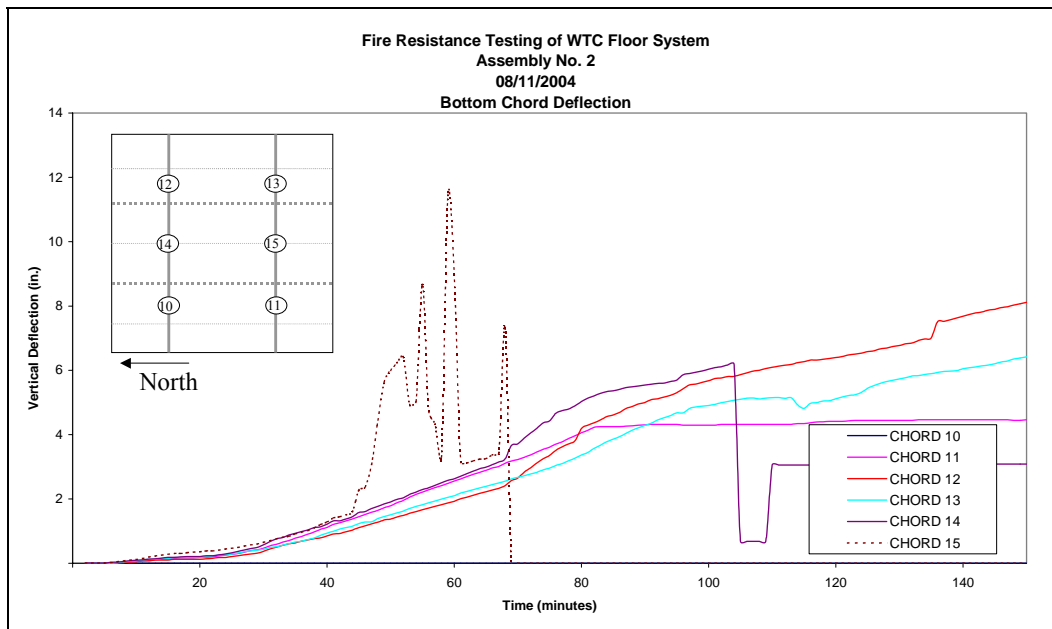

Figure 5–29. Assembly No. 2 – bottom chord deflection measurements.

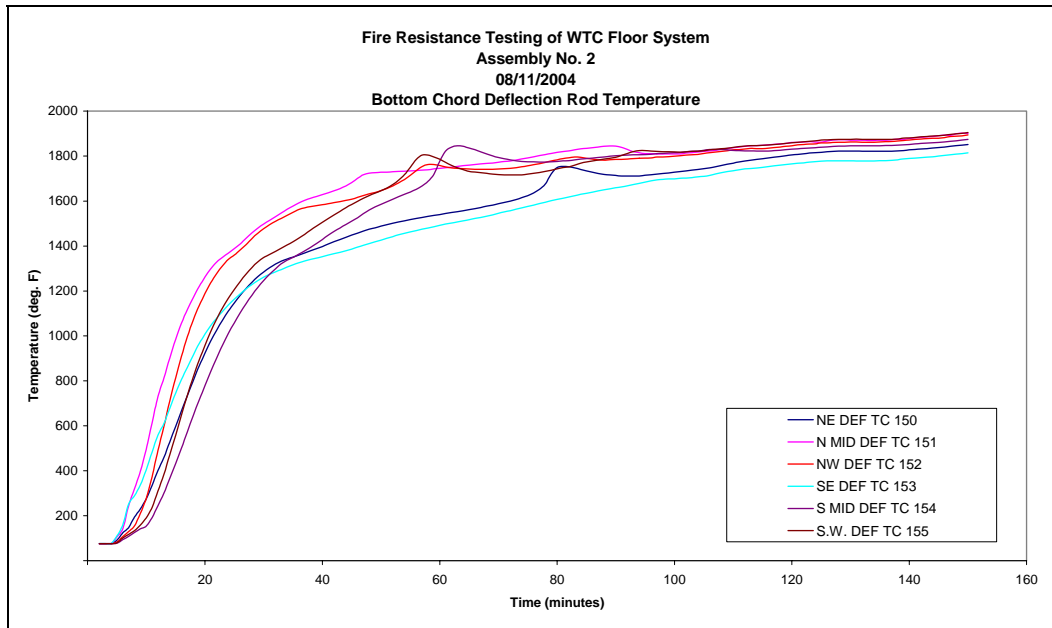

Figure 5-30. Assembly No. 2 – temperatures of bottom chord deflection rods.

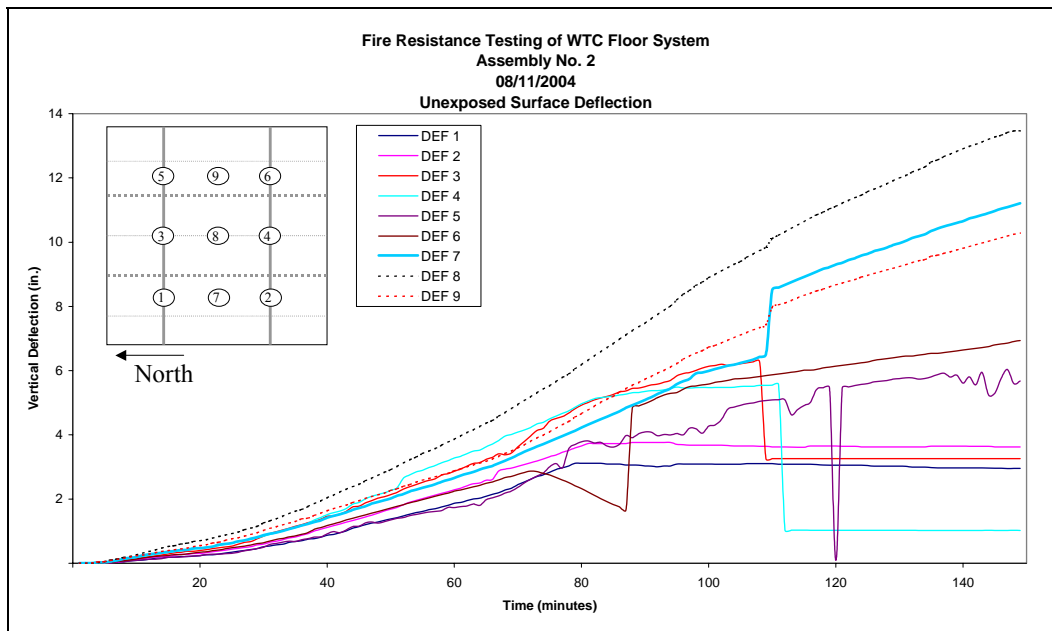

Figure 5-31. Assembly No. 2 – unexposed surface deflection measurements.

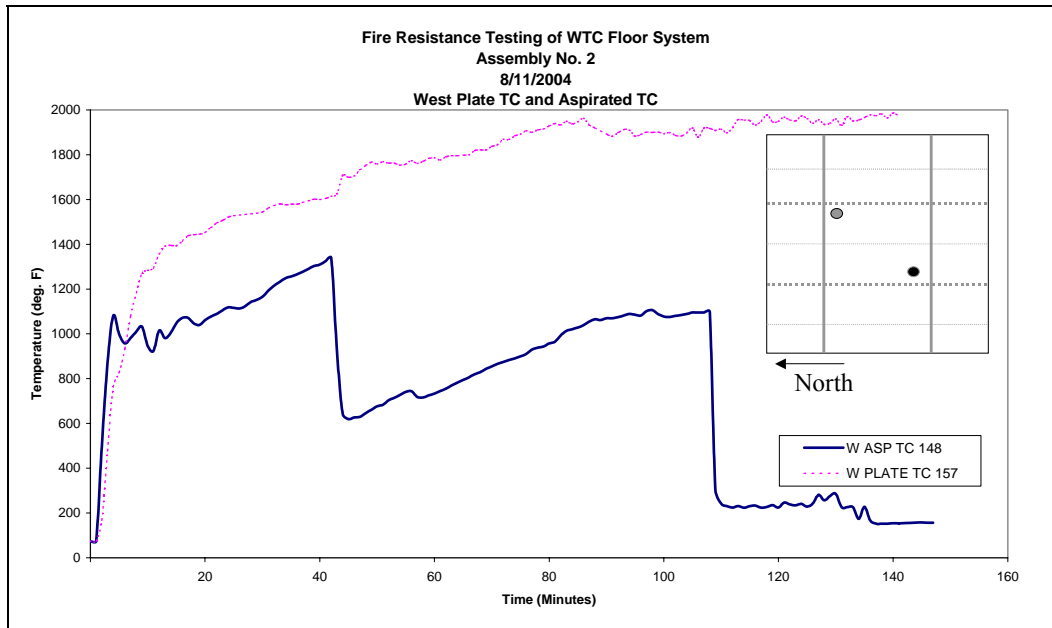

Figure 5–32. Assembly No. 2 – additional instrumentation through west opening.

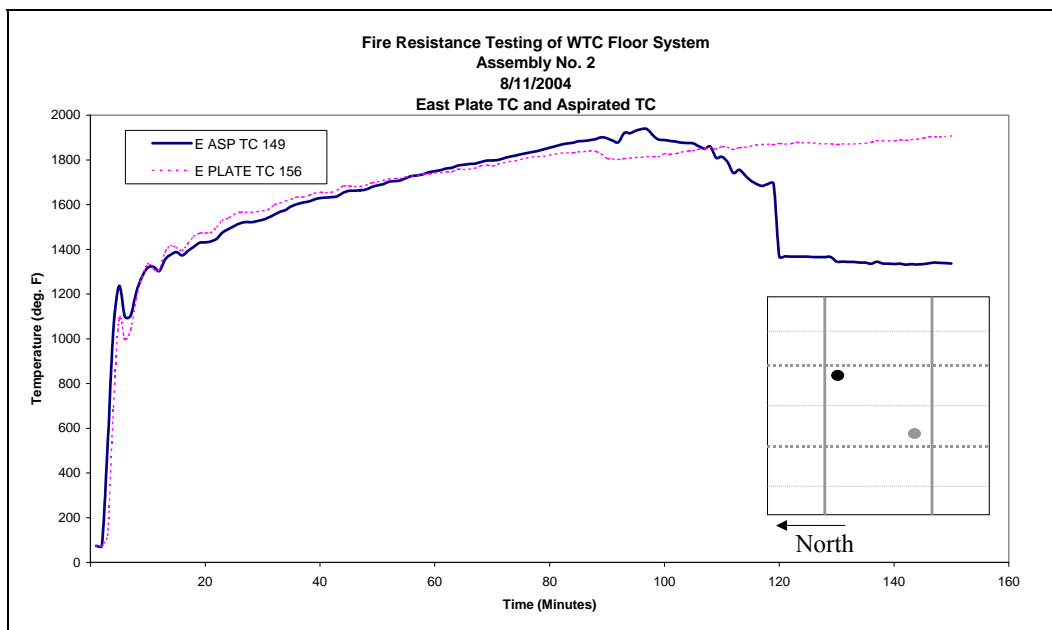

Figure 5–33. Assembly No. 2 – additional instrumentation through east opening.

5.2.3 Post-Test Observations.

Figure 5–34 shows the unexposed side of the floor assembly after all loading equipment had been removed (view looking east). Numbers shown at the centerline and quarter points are vertical deflections after cooling. All other numbers are reference dimensions as measured from the edge of the slab. Figures 5–35 through 5–37 are views of the underside of the test specimen, showing bulging of the metal deck, and deformations of the steel trusses after the test specimen had cooled and had been removed from the furnace.



Source: NIST.

Figure 5–34. Unexposed surface of Assembly No. 2 after loading equipment was removed.



Source: NIST.

Figure 5–35. View of core end diagonal strut of north main truss on Assembly No. 2.



Source: NIST.

Figure 5–36. South main truss of Assembly No. 2, looking east.



Source: NIST.

Figure 5–37. Intersection of east bridging and north main trusses on Assembly No. 2.

5.3 FIRE TEST OF ASSEMBLY NO. 3

The fire resistance test of Assembly No. 3 was conducted at the (ULC) facility on August 19, 2004 under the observation of representatives of Underwriters Laboratories Inc. and NIST.

The relative humidity of the concrete slab met the requirements prescribed in ASTM E 119.

5.3.1 Test Observations

Table 5–3 presents observations that were recorded during the conduct of the tests. All dimensions given are approximate since they were estimated by making observations through furnace viewports. Times were generally recorded to the nearest one half minute. The term “report” is used to describe a loud sound, which might be described as a “bang” or a “pop.” Because these loud reports were often accompanied by observed movement of the metal deck and the dislodging of SFRM, it is assumed that the reports signaled explosive spalling of the concrete. It was not possible to ascertain the exact location and extent of any spalling.

Table 5–3. Test observations – Assembly No. 3.

Test Time, Min	Exposed (E) or Unexposed (U) Surface	Observations
5.5	E	The steel deck buckled between the south bridging truss and the center deck support angle.
8.5	E	The steel deck buckled between the north bridging truss and the center deck support angle.
10	E	The north-south deck seam between the south bridging truss and the center deck support angle began to separate.
14	E & U	A minor report was heard and there was visual movement of the steel deck with fall off of the SFRM over-spray from the steel deck.
16	E	The center deck support angle was twisting.
19	E & U	A minor report was heard.
21	E & U	A minor report was heard.
22.5	E & U	Two minor reports were heard.
23	E & U	A minor report was heard.
26	E & U	Three minor reports were heard.
27	E & U	Two minor reports were heard.
27	E	The steel deck was becoming more deformed.
31	E	The third and fourth vertical members north of center deck support angle on the west main truss appear to be bent.
35	E & U	A minor report was heard.
55	U	Hairline cracks were observed in the concrete surface on both the east and west sides of the assembly between the edges of the loading blocks and the edges of the test frame. The cracks were more pronounced on the east side.
59	E	Visual deflection was observed on the bridging trusses.
60	E	All of the SFRM remained in place.
82	E & U	A very large report was heard. Pieces on concrete fell to the lower part of the furnace area where observations were being observed.
90	E	All of the SFRM remained in place.
92	E	The bridging trusses were becoming deformed. The deformation of the steel deck was more pronounced.
120	E	No significant changes were observed besides increased deflection. All of the SFRM remained in place.
140	E	The SFRM had separated from the bottom chord of the north bridging truss but had not fallen to the furnace floor.
152	E	The area, approximately 8 inches long, described in the 140 min. observation fell to the furnace floor.
180	E	No significant changes were observed besides increased deflection.
210	E	No significant changes were observed.
210.75	E & U	Furnace fire extinguished. Fire test terminated.

5.3.2 Data

All data shown in the following figures (Figures 5–38 through 5–49) are unedited for the entire duration of the test. However, not all data shown is reliable due to the limitations of the instrumentation, i.e. thermocouples, radiometers, and calorimeters. Data may become unreliable past the rating period when structural events occur that can dislodge the instrumentation. Also, protective insulation of the thermocouple wire may burn away, and the individual wires make contact with themselves and/or neighboring wires rendering the data unreliable. Appendix H gives a listing of the times that instrumentation failed to give reliable data, as determined by UL.

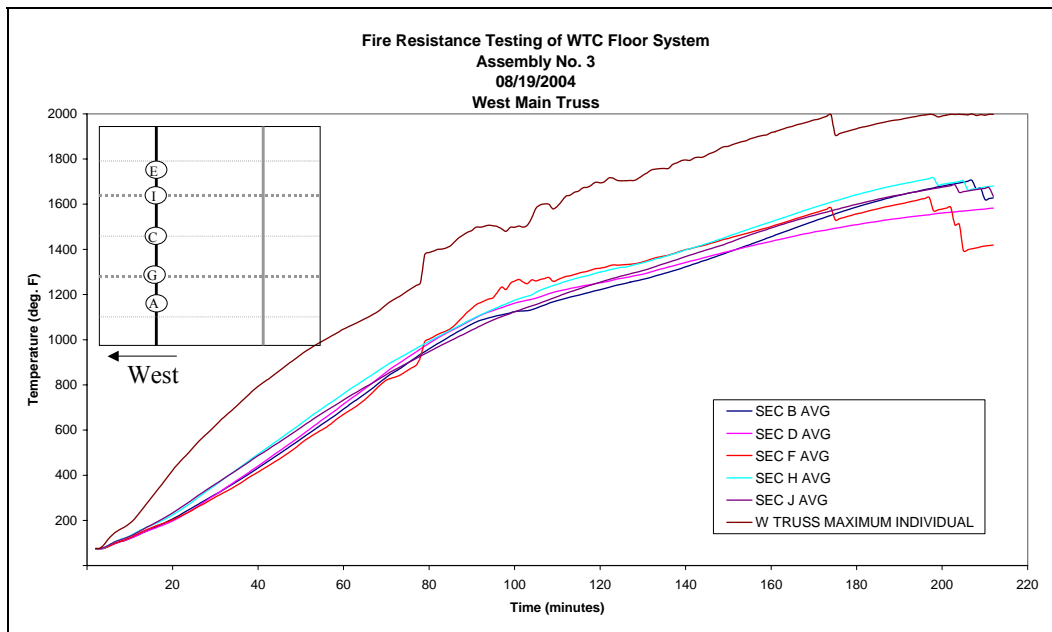

Figure 5–38. Assembly No. 3 – average and maximum individual temperatures on west main truss.

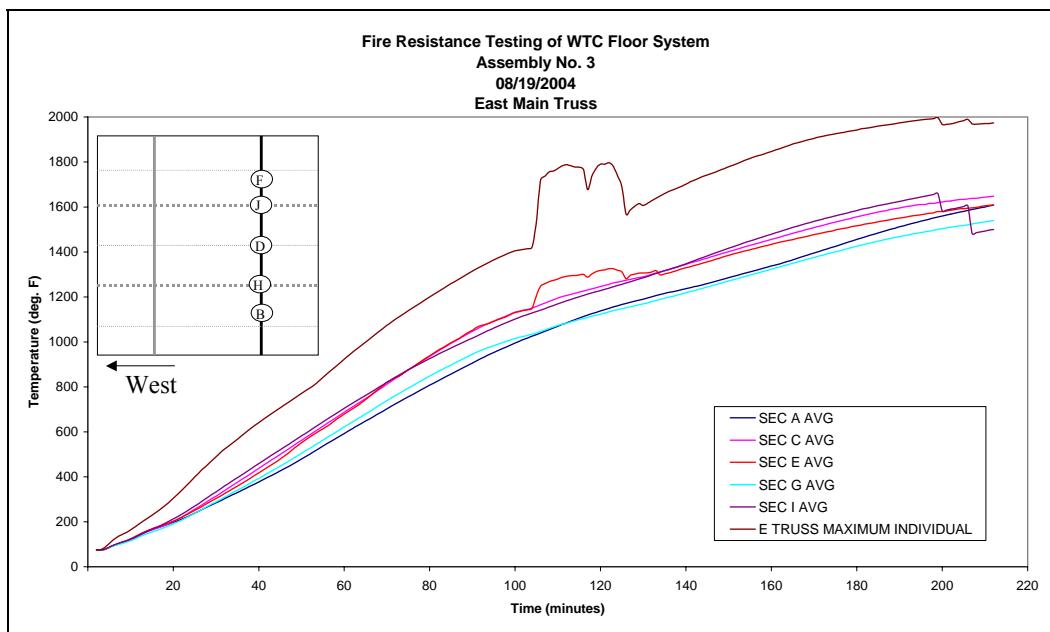

Figure 5–39. Assembly No. 3 – average and maximum individual temperatures on east main truss.

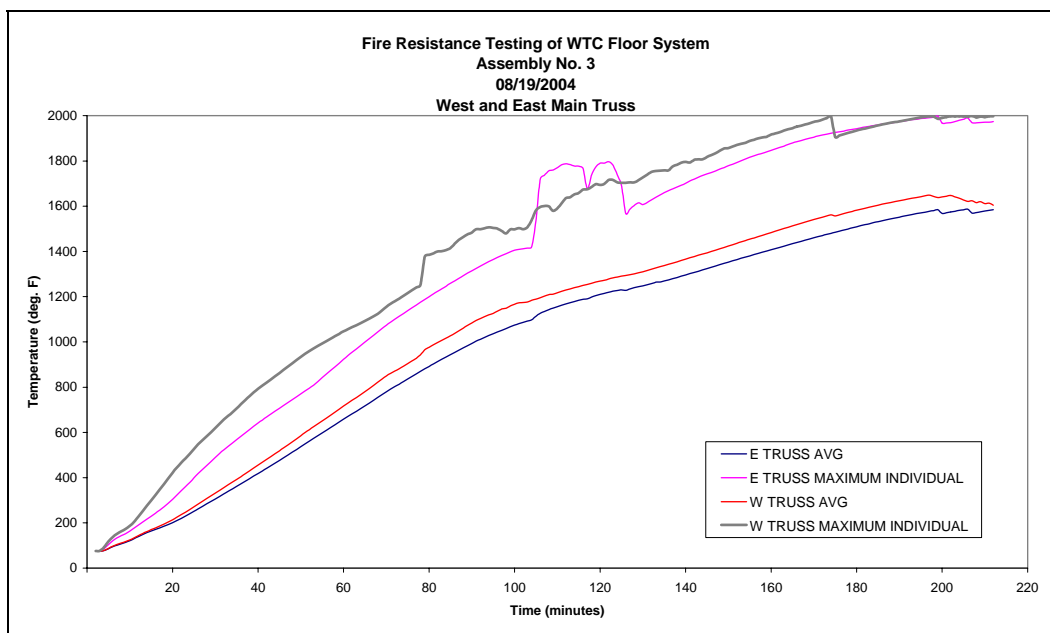

Figure 5–40. Assembly No. 3 – overall average and maximum individual temperatures on west and east main trusses.

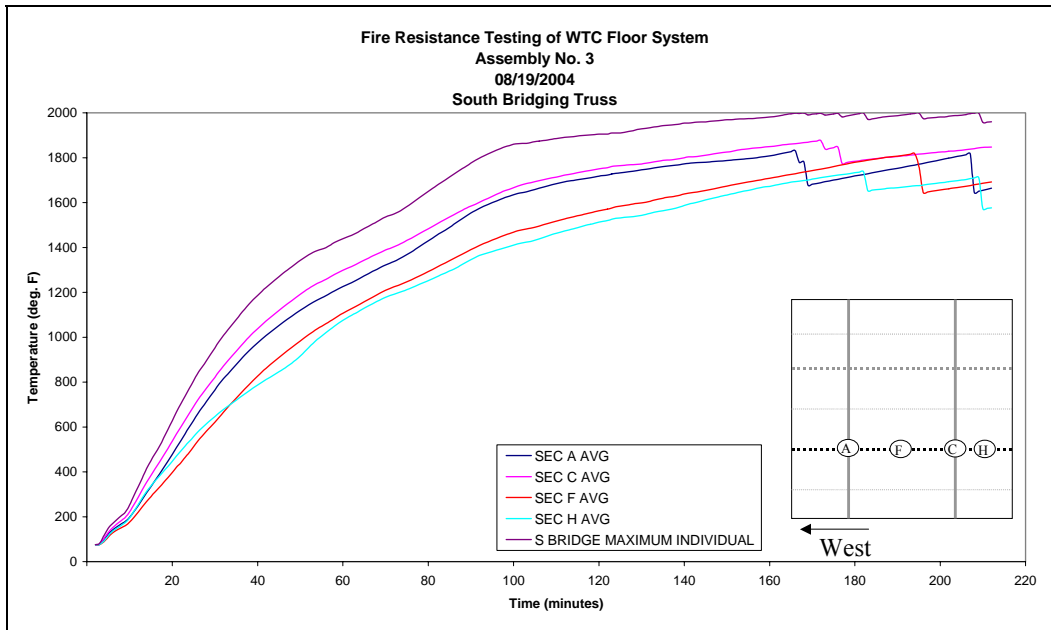

Figure 5-41. Assembly No. 3 – average and maximum individual temperatures on south bridging truss.

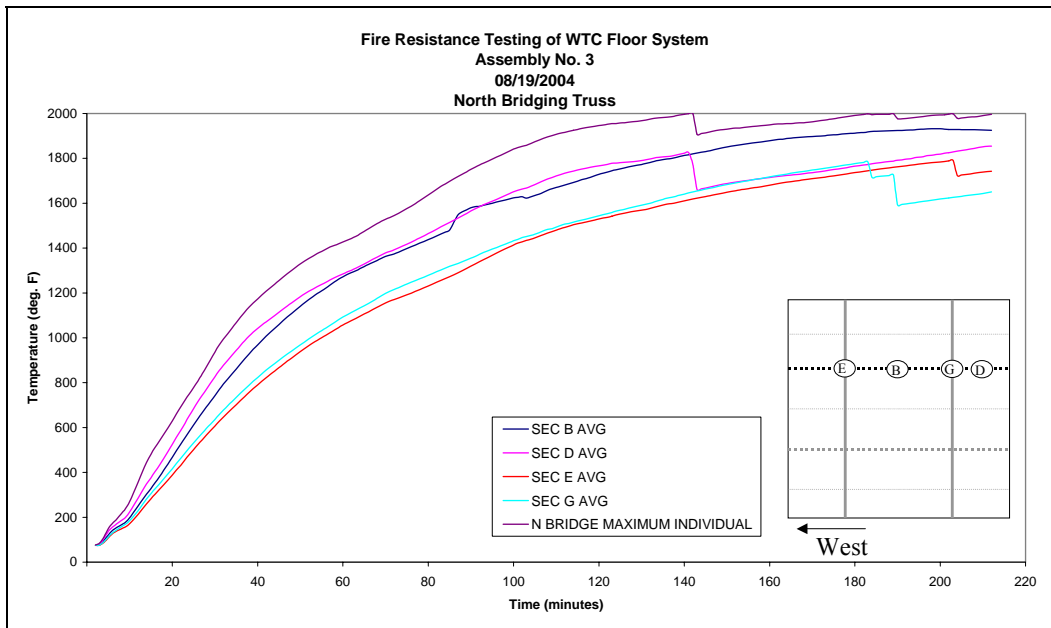

Figure 5-42. Assembly No. 3 – average and maximum individual temperatures on north bridging truss.

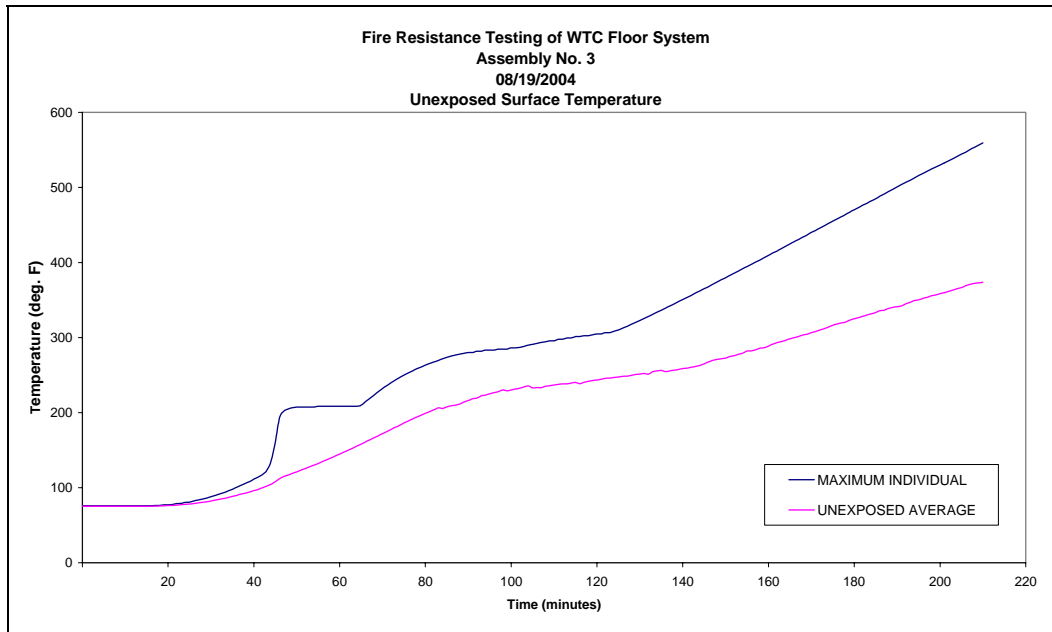

Figure 5-43. Assembly No. 3 – average and maximum individual temperatures on unexposed surface.

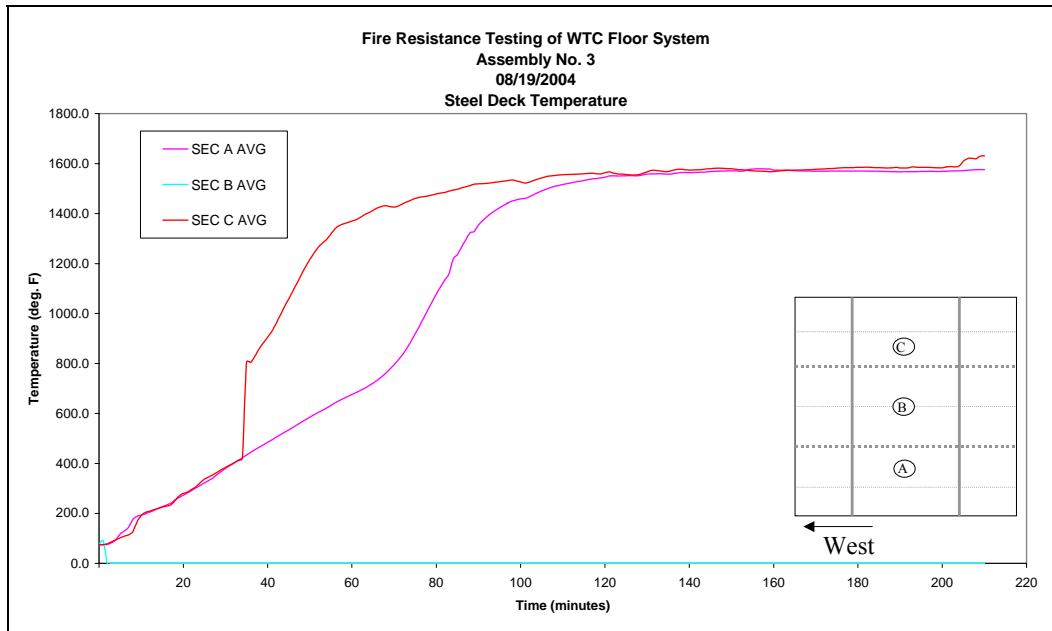

Figure 5-44. Assembly No. 3 – average temperatures on steel deck.

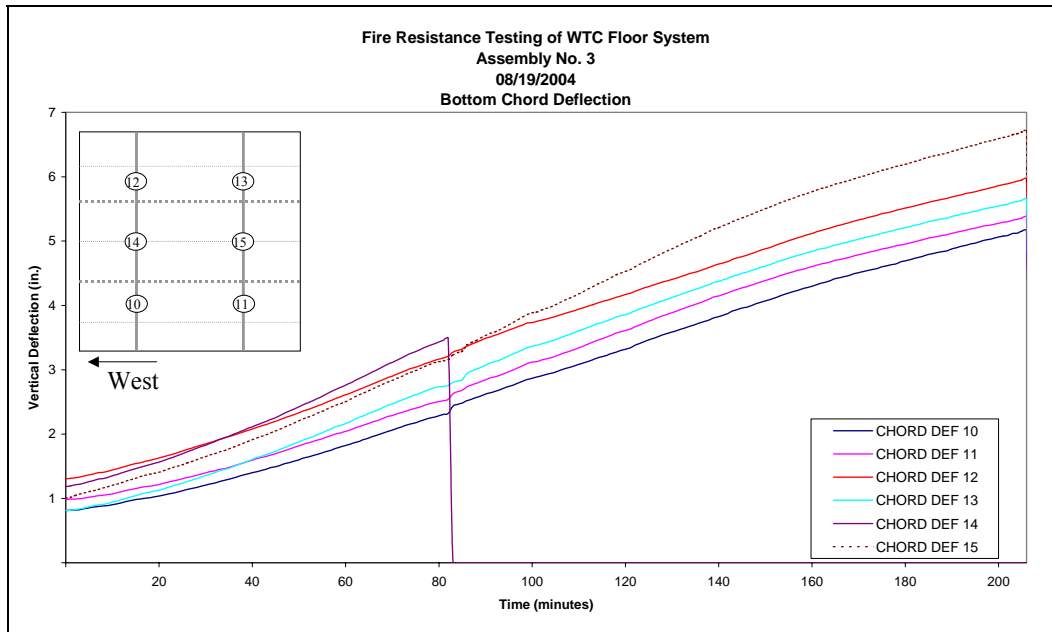

Figure 5–45. Assembly No. 3 – bottom chord deflection measurements.

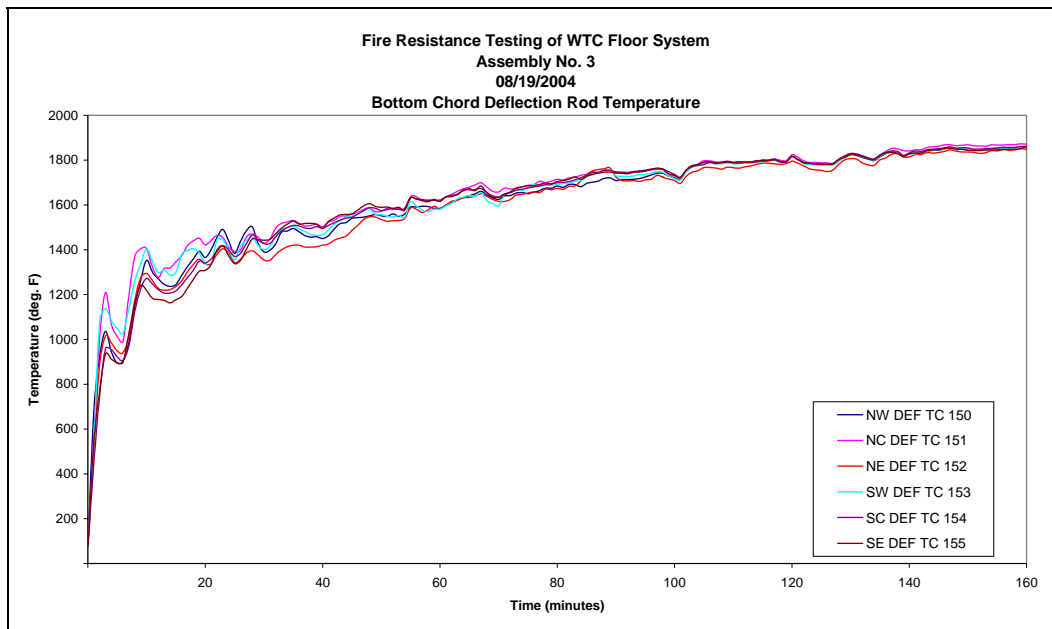

Figure 5–46. Assembly No. 3 – temperatures of bottom chord deflection rods.

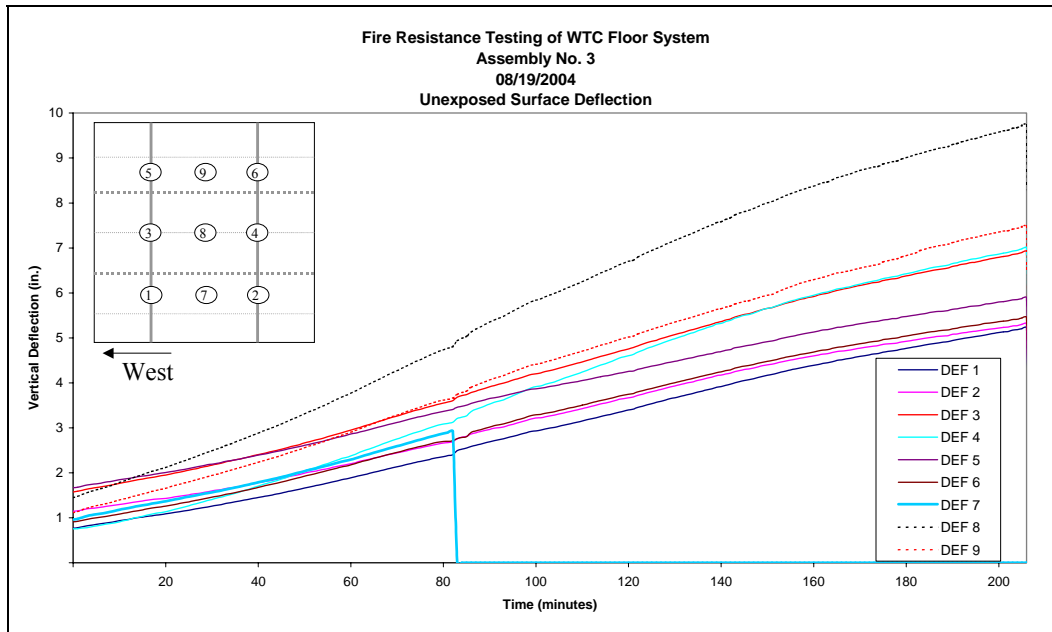

Figure 5-47. Assembly No. 3 – unexposed surface deflection measurements.

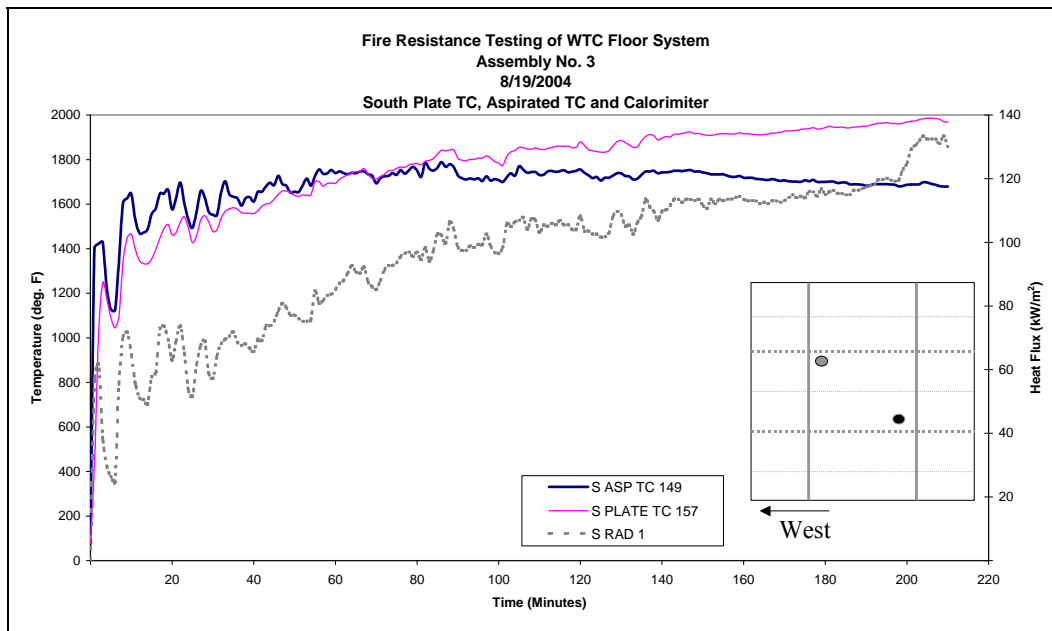

Figure 5-48. Assembly No. 3 – additional instrumentation through south opening.

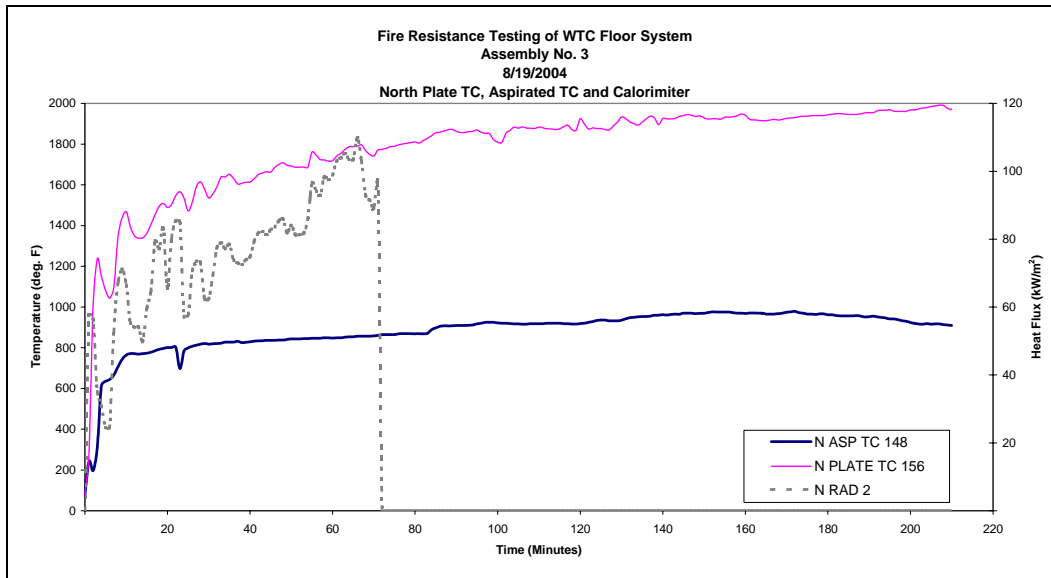
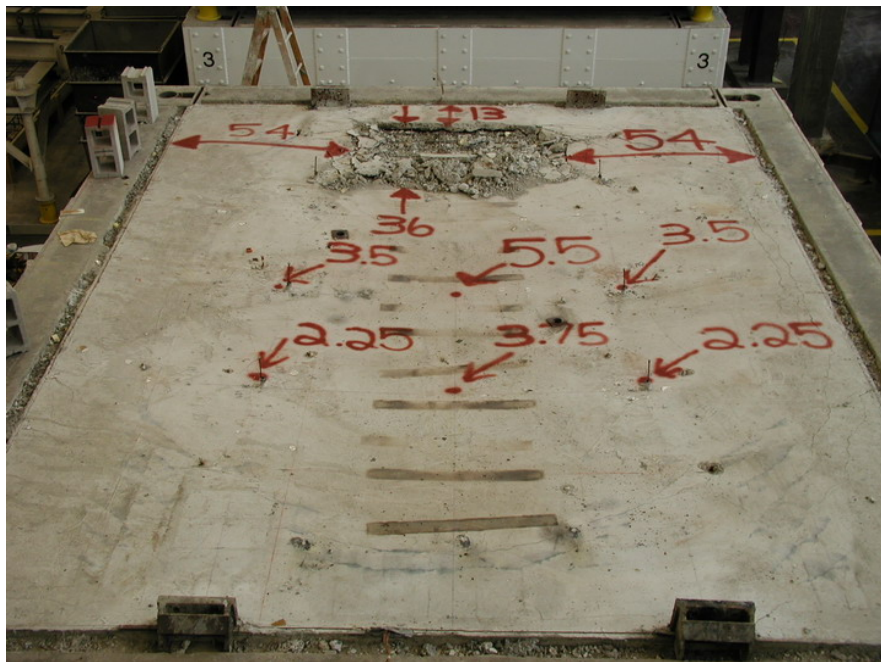

Figure 5–49. Assembly No. 3 – additional instrumentation through north opening.

5.3.3 Post-Test Observations

Figure 5–50 shows the unexposed side of floor assembly No. 3 after all loading equipment had been removed (view looking north). Numbers shown at the centerline and quarter points are vertical deflections after cooling. All other numbers are reference dimensions as measured from the edge of the slab. Figures 5–51 through 5–53 are additional views of the post-test condition of the test specimen.



Source: NIST.

Figure 5–50. Unexposed surface of Assembly No. 3 after loading equipment was removed.



Source: NIST.

Figure 5–51. Detail of spalling concrete at north end of Assembly No. 3.



Source: NIST.

Figure 5–52. View of column-end diagonal strut of west main truss on Assembly No. 3.



Source: NIST.

Figure 5–53. Intersection of north bridging and west main truss on Assembly 3.

5.4 FIRE TEST OF ASSEMBLY NO. 4

The fire resistance test of Assembly No. 4 was conducted at the UL Northbrook facility (ULN) on August 25, 2004 under the observation of representatives of Underwriters Laboratories Inc., and NIST.

The relative humidity of the concrete slab met the requirements prescribed in ASTM E 119.

5.4.1 Test Observations

Table 5–4 presents observations that were recorded during the conduct of the test. All dimensions given are approximate since they were estimated by making observations through furnace viewports. Times were generally recorded to the nearest one quarter minute. The term “report” is used to describe a loud sound, which might be described as a “bang” or a “pop.” Because these loud reports were often accompanied by observed movement of the metal deck and the dislodging of SFRM, it is assumed that the reports signaled explosive spalling of the concrete. It was not possible to ascertain the exact location and extent of any spalling. After the concrete spalling at approximately 55 minutes, ceramic fiber insulation was placed over the opening in the concrete to protect the hydraulic loading equipment from the heat escaping the furnace, thereby, allowing the test to continue.

Table 5–4. Test observations – Assembly No. 4.

Test Time, Min	Exposed (E) or Unexposed (U) Surface	Observations
4.25	E	Slight buckling of the steel deck was observed near the bridging trusses. The buckling was more pronounced near the north bridging truss.
7	E	There was heavy deck buckling in a east-west direction 1 ft south of the center deck support angle.
8	E	The center deck support angle was bowing towards the north.
9.5	E	The finish on the bridging trusses was peeling away.
14	E/U	A minor report was heard.
14.75	E/U	Two minor reports were heard approximately 1 second apart.
15.5	E/U	Two minor reports were heard approximately 1 second apart.
15.75	E/U	A report was heard.
16	E	The reports were becoming louder and more frequent.
17.5	E	Over spray of the SFRM on the steel deck was falling from the assembly.
18.25	E	The top chord of the south bridging truss was becoming deformed.
20	E/U	The reports were becoming less frequent and louder.
20.5	E	The steel deck became heavily deformed south of the center deck support angle.
22	E/U	The reports were more frequent.
23	E/U	A loud report was heard.
24.75	E	The top chord of the north bridging truss was becoming deformed.
31.5	E	The reports were becoming less frequent.
35.75	E	The SFRM became darker in color.
41	E/U	A report was heard. It was the first one since the 31.5 minute observation.
42	E/U	A loud report was heard.
44.75	E/U	Three reports were heard approximately 1 second apart.
48.5	E/U	A loud report was heard.
51	E/U	A very loud report was heard.
51	E	Visible steel deck deflection between the center deck support angles and the bridging trusses.
54	E	The bridging trusses were bowing downward near their centers.
55.25	E/U	A very loud report was heard. Pieces on concrete fell to the lower part of the furnace area were observations were being observed.
56	E	The center deck span west of the west main truss was bowing downward past the lower chord of the main truss.
60	E	All of the SFRM on the main trusses remained in place.
60.25	E	The center deck support angle was twisting where it interfaced with the main trusses.
73	E	Visual deck deflection near the center of the assembly continued.
88	E/U	No reports were heard since the 55.25 minute observation.
90	E	All of the SFRM on the main trusses remained in place.
110	E	A minor report was heard.
120	E	All of the SFRM on the main trusses remained in place.
120	E/U	Furnace Fire extinguished at the request of the submitter.

5.4.2 Data

All data shown in the following figures (Figures 5–54 through 5–65) are unedited for the entire duration of the test. However, not all data shown is reliable due to the limitations of the instrumentation, i.e. thermocouples, radiometers, and calorimeters. Data may become unreliable past the rating period when structural events occur that can dislodge the instrumentation. Also, protective insulation of the thermocouple wire may burn away, and the individual wires make contact with themselves and/or neighboring wires rendering the data unreliable. Appendix H gives a listing of the times that instrumentation failed to give reliable data, as determined by UL.

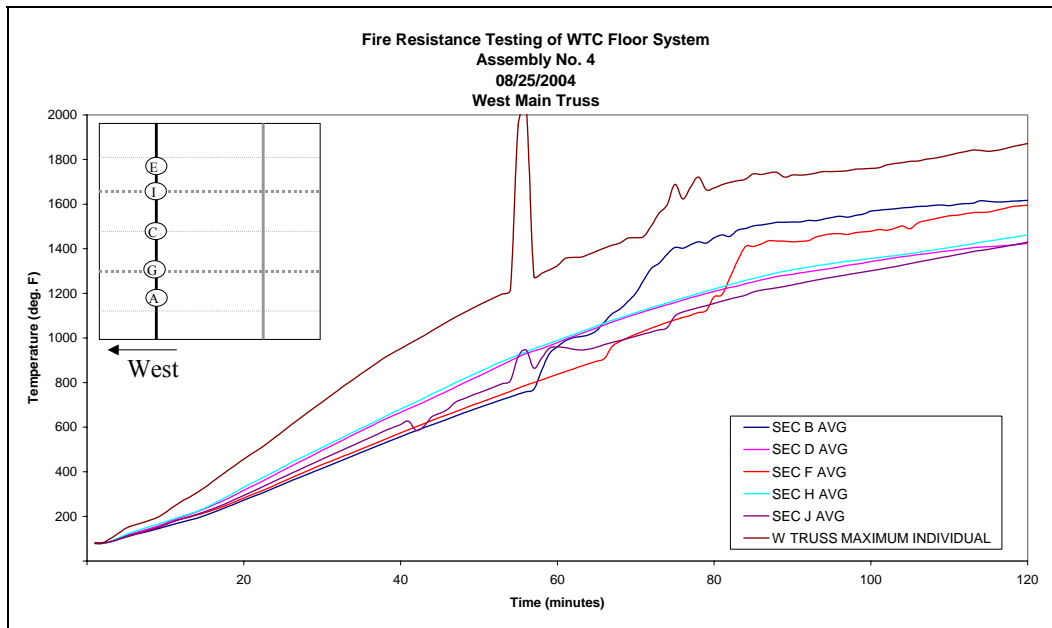

Figure 5–54. Assembly No. 4 – average and maximum individual temperatures on west main truss.

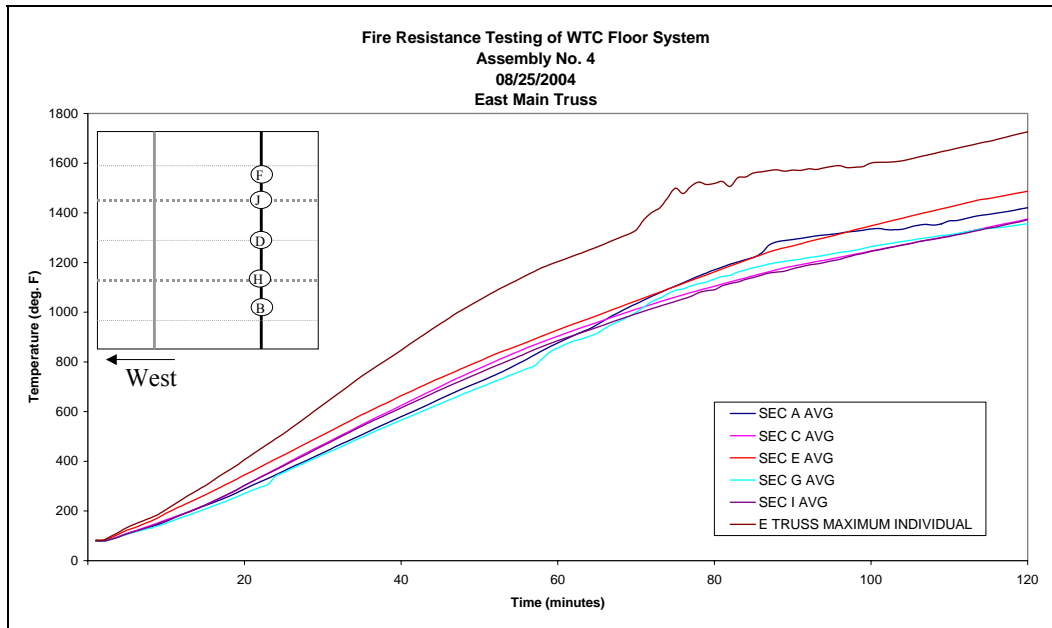

Figure 5–55. Assembly No. 4 – average and maximum individual temperatures on east main truss.

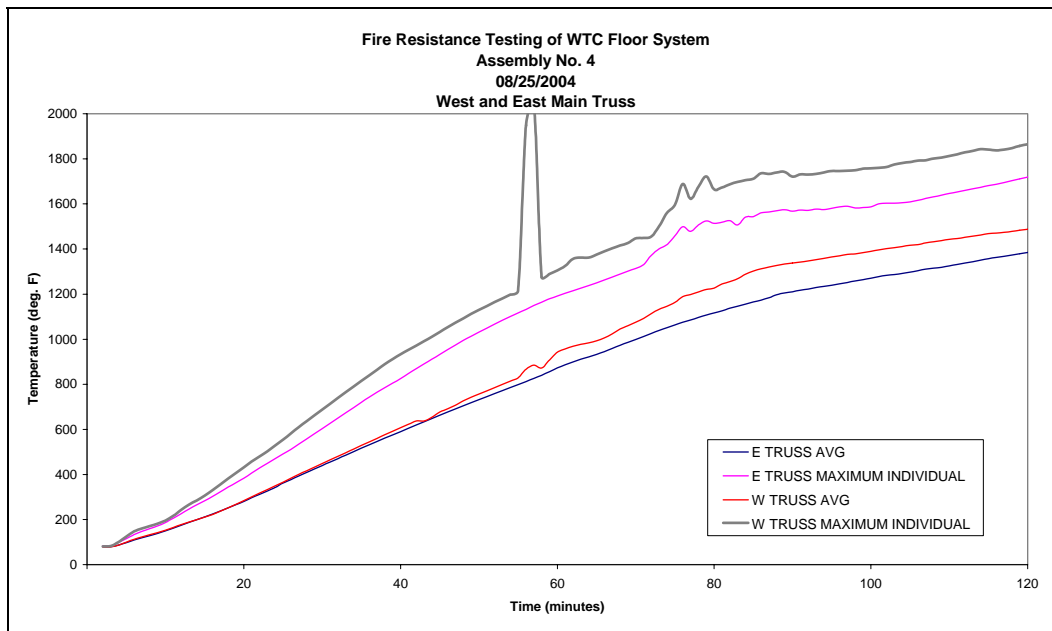

Figure 5–56. Assembly No. 4 – overall average and maximum individual temperatures on west and east main trusses.

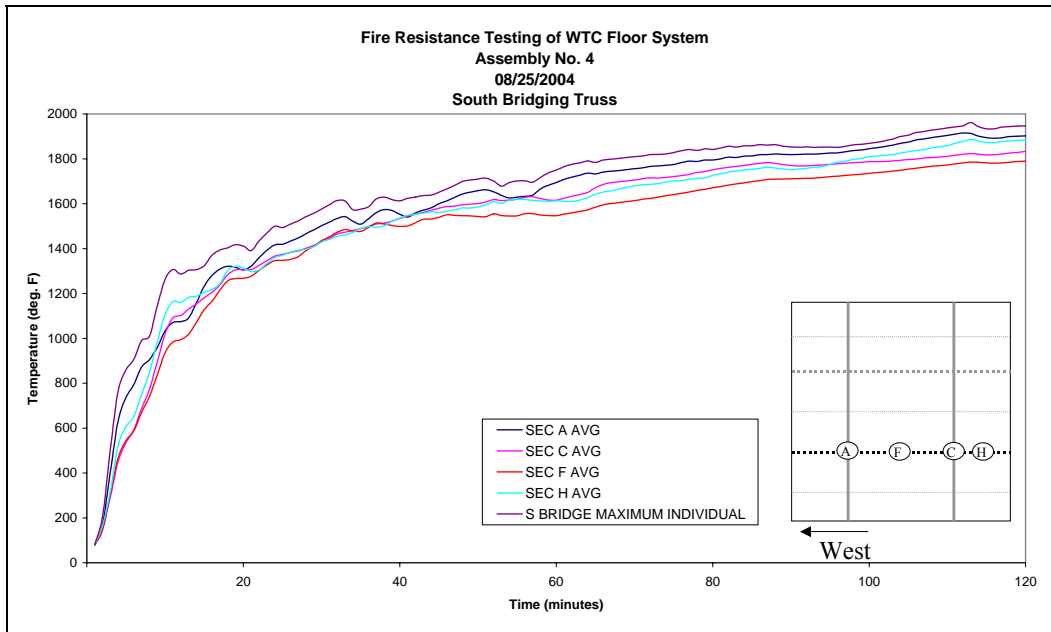

Figure 5–57. Assembly No. 4 – average and maximum individual temperatures on south bridging truss.

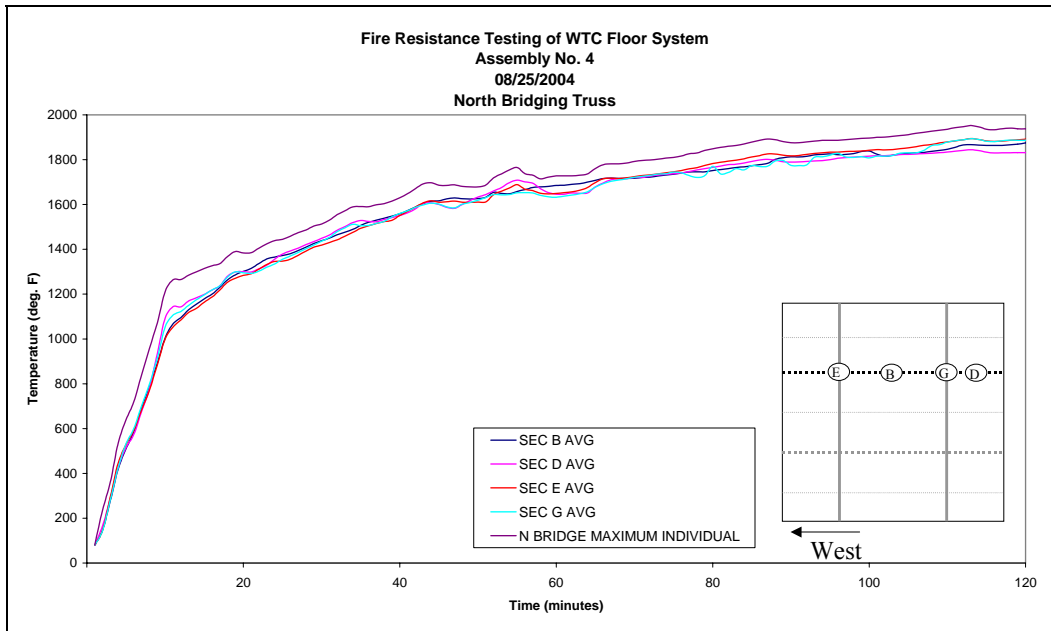

Figure 5–58. Assembly No. 4 – average and maximum individual temperatures on north bridging truss.

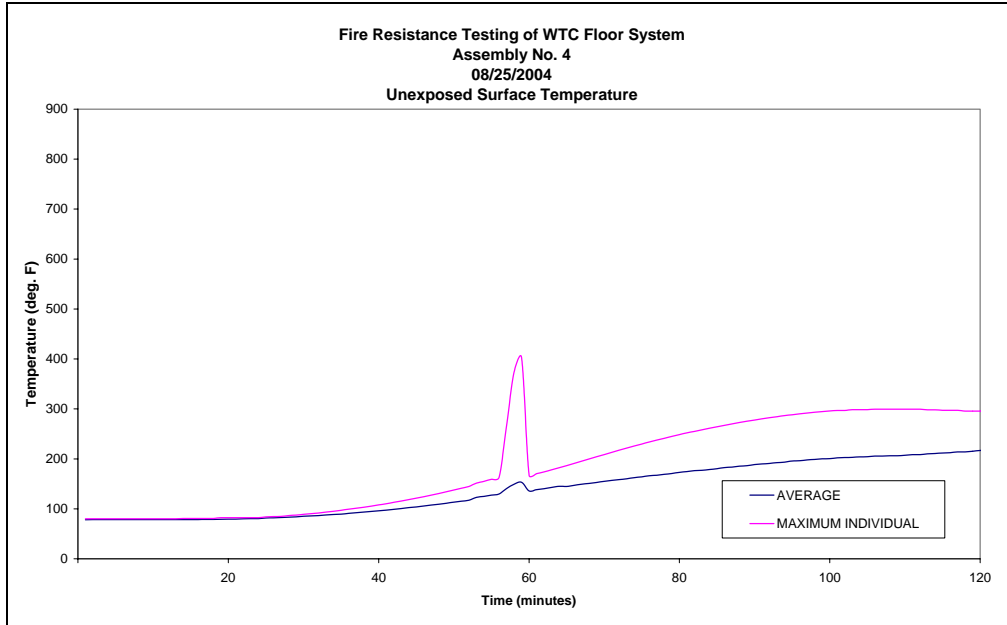

Figure 5–59. Assembly No. 4 – average and maximum individual temperatures on unexposed surface.

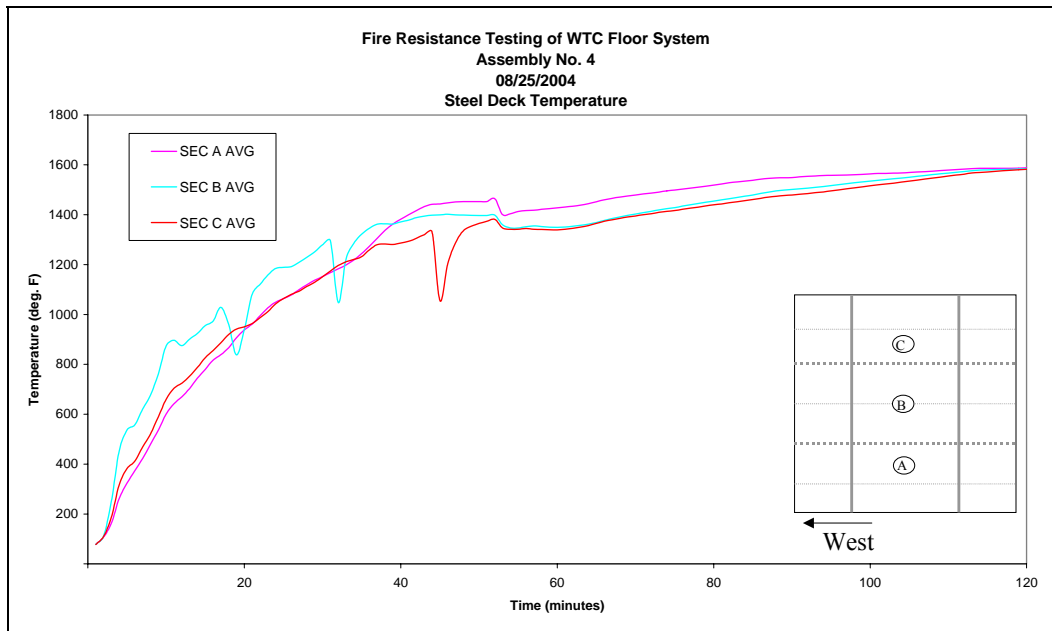

Figure 5–60. Assembly No. 4 – average temperatures on steel deck.

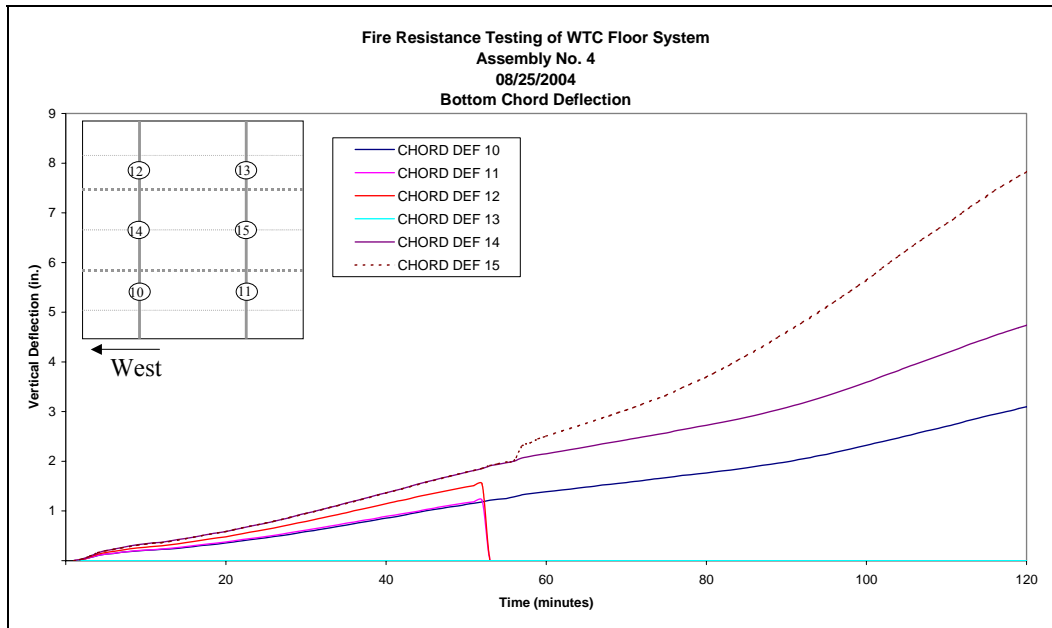

Figure 5–61. Assembly No. 4 – bottom chord deflection measurements.

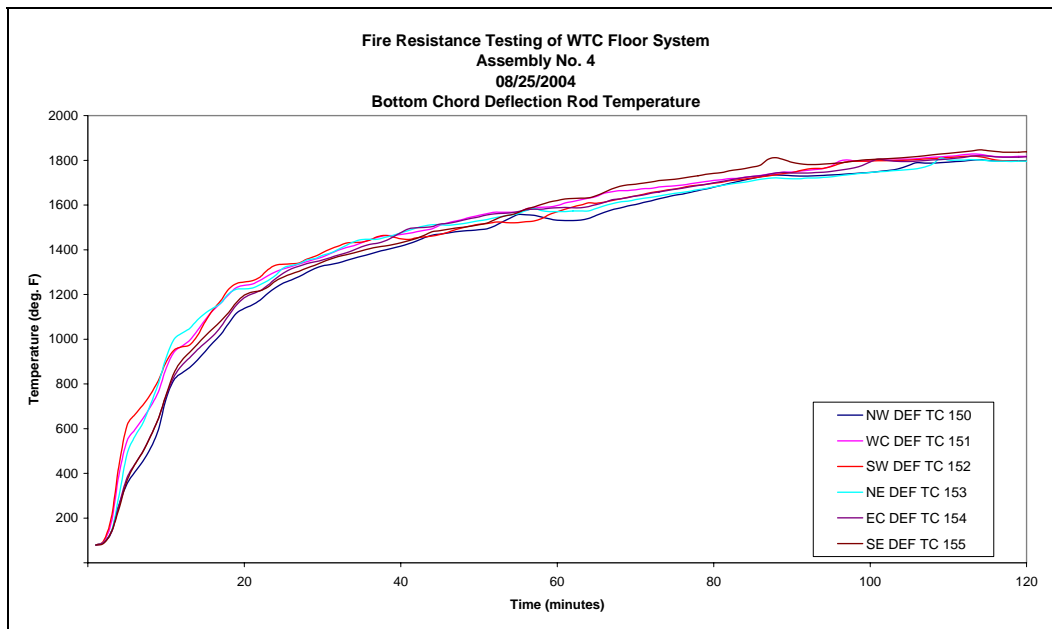

Figure 5–62. Assembly No. 4 – temperatures of bottom chord deflection rods.

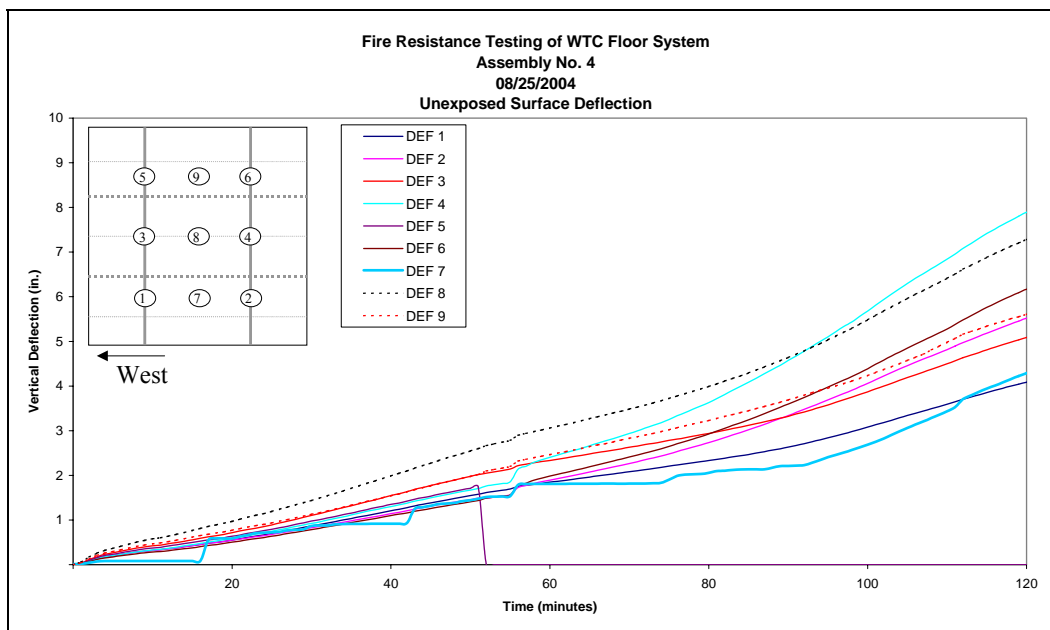

Figure 5–63. Assembly No. 4 – unexposed surface deflection measurements.

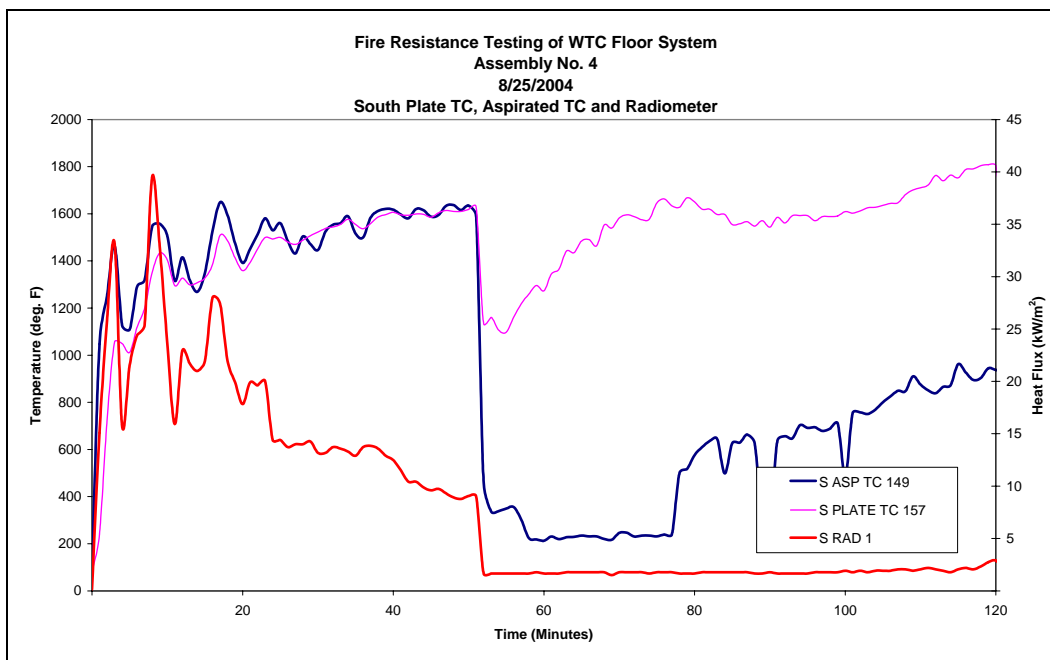

Figure 5–64. Assembly No. 4 – additional instrumentation through south opening.

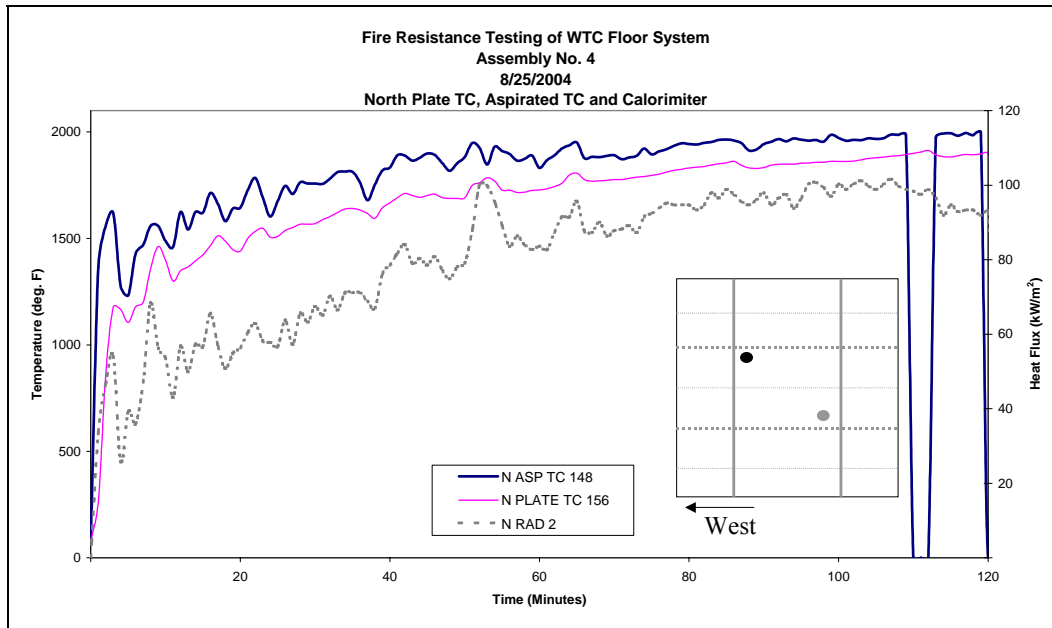
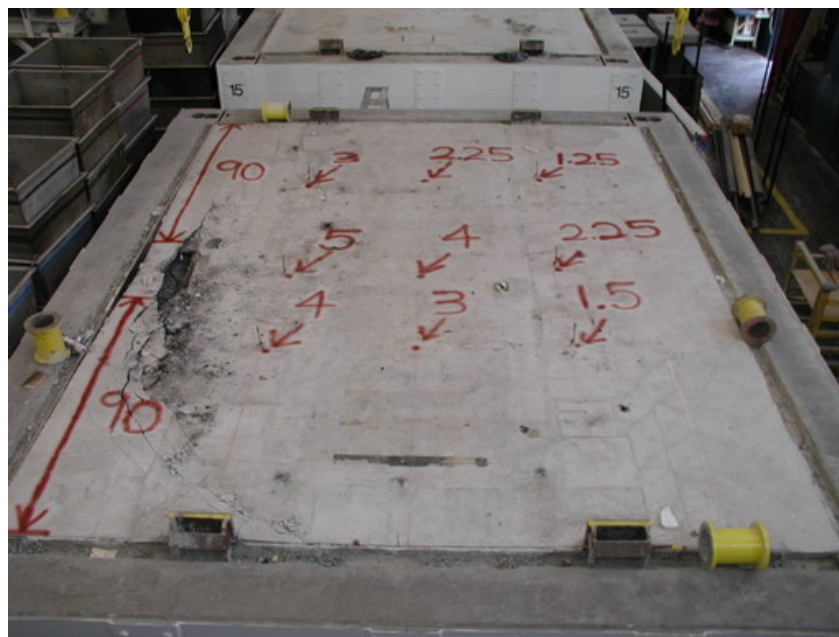

Figure 5–65. Assembly No. 4 – additional instrumentation through north opening.

5.4.3 Post-Test Observations

Figure 5–66 shows the unexposed side of the assembly after all loading equipment was removed (view looking north). Numbers shown at the centerline and quarter points are vertical deflections after cooling. All other numbers are reference dimensions as measured from the edge of the slab. Figures 5–67 through 5–70 are additional views of the post-test condition of the test specimen.



Source: NIST.

Figure 5–66. Unexposed surface of Assembly No. 4 after loading equipment was removed.



Source: NIST.

Figure 5–67. Unexposed surface of Assembly No. 4, view of concrete spalling on west side of assembly.



Source: NIST.

Figure 5–68. Unexposed surface of Assembly No. 4, close-up of concrete spalling on west side of assembly.



Source: NIST.

Figure 5–69. Intersection of north bridging and west main truss on Assembly 4.



Source: NIST.

Figure 5–70. View looking north of south bridging truss at location where concrete spalling occurred on Assembly 4.

5.5 FIRE RESISTANCE RATINGS

All four fire resistance tests were conducted for as long as practical to obtain as much information as possible. As such, the tests were not stopped when the first end-point criteria was reached. Rather, the tests were continued until it was determined that collapse of the test specimen was imminent or until instrumentation critical to the determination of safe continuation of the test had failed to provide reliable readings. Additionally, excessive deflection of the floor system would sometimes contact and damage furnace instrumentation making it impractical to continue the test.

5.5.1 Test Assembly No. 1

Assembly No. 1 was fire tested on August 7, 2004 in accordance with ASTM E 119-61 and ASTM E 119-00a. The test was continued for 116 minutes and terminated when collapse of the assembly was imminent. The main trusses reached a maximum individual temperature of 1,300 °F (704 °C) (at thermocouple No. 18), as defined in Paragraph 32.1.3 of ASTM E 119-00a, at 62 min. The average limiting temperature of 1,100 °F (593 °C), as defined in Paragraph 32.1.3 of ASTM E 119, was reached at 66 minutes at section E. The unexposed surface temperatures exceeded the maximum individual requirement of 325 °F (163 °C) rise over ambient temperatures as defined in Paragraphs 7.4 and 32.1.2 of ASTM E 119-00a at 111 minutes. For safety reasons, access to the top of the floor assembly was not permitted during the test and, consequently, testing for unexposed surface conditions that would ignite cotton waste was not done.

5.5.2 Test Assembly No. 2

Assembly No. 2 was fire tested on August 11, 2004 in accordance with ASTM E 119-61 and ASTM E 119-00a. The test was continued for 146 minutes and terminated when the vertical deflection of the assembly exceeded the capability of the instrumentation to accurately measure the deflection at the center of the test assembly. The main trusses reached maximum individual temperature of 1,300 °F (704 °C) at 62 minutes. The average limiting temperature of 1,100 °F (593 °C) was reached at 76 minutes at Section C. Neither the maximum or average unexposed surface temperatures were exceeded throughout the duration of the fire test. As described for the test of Assembly No. 1, testing for unexposed surface conditions that would ignite cotton waste was not done.

5.5.3 Test Assembly No. 3

Assembly No. 3 was fire tested on August 19, 2004 in accordance with ASTM E 119-61 and ASTM E 119-00a. The test was continued for 210 minutes and terminated when the vertical deflection of the assembly exceeded the capability of the instrumentation to accurately measure the deflection at the center of the test assembly. The main trusses reached a maximum individual temperature of 1,300 °F (704 °C) at 80 minutes. The average limiting temperature of 1,100 °F (593 °C) was reached at 86 minutes at Section F. The unexposed surface temperatures exceeded the maximum individual temperature requirement of 325 °F (163 °C) rise over ambient temperature at 157 min. The average temperature of the unexposed surface limit was reached at 180 minutes. Since the top of the floor assembly was loaded with concrete block, water containers, and hydraulic actuators, access to most of the concrete surface was limited and testing for unexposed surface conditions that would ignite cotton waste was not done.

5.5.4 Test Assembly No. 4

Assembly No. 4 was fire tested on August 25, 2004 in accordance with ASTM E 119-61 and ASTM E 119-00a. The test was continued for 120 minutes and terminated when collapse of the assembly was imminent. The main trusses reached a maximum individual temperature of 1,300 °F (704 °C) at 58 minutes. The average limiting temperature of 1,100 °F (593 °C) was reached at 66 minutes at Section B. The unexposed surface temperatures exceeded the maximum individual requirement of 325 °F (163 °C) rise over ambient temperatures at 58 minutes. As described for the test of Assembly No. 3, testing for unexposed surface conditions that would ignite cotton waste was not done.

5.5.5 Summary Table

Based on the results of the fire tests, assemblies 1 through 4 achieved the hourly ratings shown in Table 5-5.

Table 5-5. Times to reach ASTM E 119 end-point criteria and ASTM E 119 hourly ratings.

Test	Description	Times to Reach End-Point Criteria (min)						Test Terminated (min)	Standard Fire Test Rating (hr)		
		Temperature on Unexposed Surface		Steel Temperatures		Failure to Support Load	ASTM E 119-61 Rating		ASTM E 119-00 Restrained Rating	ASTM E 119-00 Unrestrained Rating	
		Average (Ambient +250°F)	Maximum (Ambient +325°F)	Average (1100°F)	Maximum (1300°F)						
											(see Fig. 5-1)
1	35 ft restrained ¾ in SFRM	---	111 (see Fig. 5-6)	66 (see Fig. 5-1)	62 (see Fig. 5-1)	(3)	116 ⁽¹⁾	1½	1½	1	
2	35 ft unrestrained ¾ in SFRM	---	---	76 (Fig. 5-20)	62 (Fig. 5-20)	(3)	146 ⁽²⁾	2	---	2	
3	17 ft restrained ¾ in SFRM	180 (see Fig. 5-41)	157 (Fig. 5-41)	86 (Fig. 5-36)	76 (Fig. 5-36)	(3)	210 ⁽²⁾	2	2	1	
4	17 ft restrained ½ in SFRM	---	58 (Fig. 5-57)	66 (Fig. 5-52)	58 (Fig. 5-52)	(3)	120 ⁽¹⁾	¾	¾	¾	

Notes: (1) Test terminated due to imminent collapse

(2) Test terminated when vertical displacement exceeded capability to measure accurately

(3) Did not occur

Chapter 6

DISCUSSION OF RESULTS

6.1 COMPARISON OF RESULTS

Results of the four fire resistance tests are compared in this section. First, it is useful to compare the fire environment for all four tests. The ASTM E 119 Standard requires that the prescribed time-temperature relationship be followed as determined by the average of individual temperature measurements within the furnace. For the tests conducted here, additional instrumentation was installed to characterize the thermal environment and, in particular, the exposure at different locations relative to the floor assembly. Lastly, the performance of the floor assembly, as evidenced by temperatures on the unexposed side of the floor slab, temperatures of the steel trusses, and by the deflections of the slabs and supporting steel members, is presented.

6.1.1 Furnace Control Temperatures

The average furnace temperatures during all four tests and the target time-temperature relationship prescribed by ASTM E 119 are shown in Fig. 6–1. It is seen that the average furnace control temperatures were very similar and indeed met the requirements of ASTM E 119.

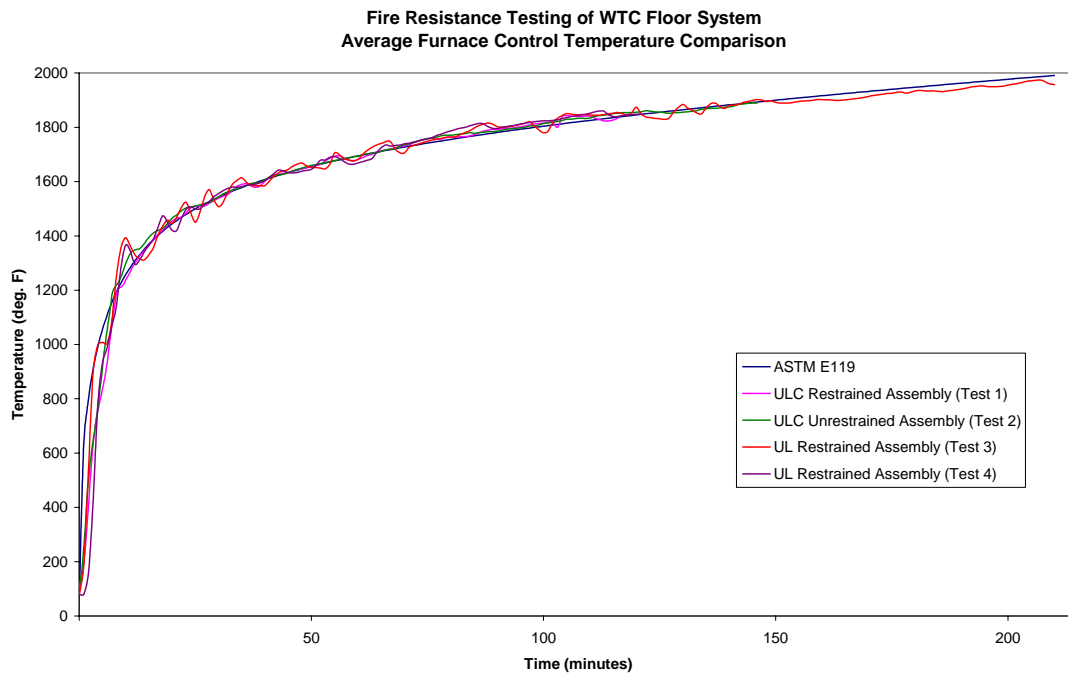

Figure 6–1. Comparison of average furnace control temperatures.

6.1.2 Furnace Thermal Environment

Additional instrumentation was included in all four tests to further characterize the thermal environment of the exposing fire. Aspirated thermocouples, plate thermocouples and radiometers were located at the underside of the metal deck and at the elevation of the bottom chord and recordings were made throughout the duration of the tests.

Plate Thermocouple Measurements

Figures 6–2 and 6–3 show temperatures recorded by the plate thermocouples for Test No. 2 (ULC furnace) and Test No. 4 (ULN furnace). Temperatures recorded at the bottom chord are presented in Fig. 6–2, and those recorded at the underside of the metal deck are shown in Fig. 6–3. These two plots show that temperatures measured at two locations are very similar between the two furnaces. Note that the plate TC at the metal deck in Test 4 (ULN) gave unreliable data after approximately 50 min. This time is consistent with observations of very loud report and visible steel deck deflection recorded at 51 min (see Table 5–4). This plate TC was dislodged from its initial position, relative to the metal deck, and readings beyond 50 min cannot be interpreted.

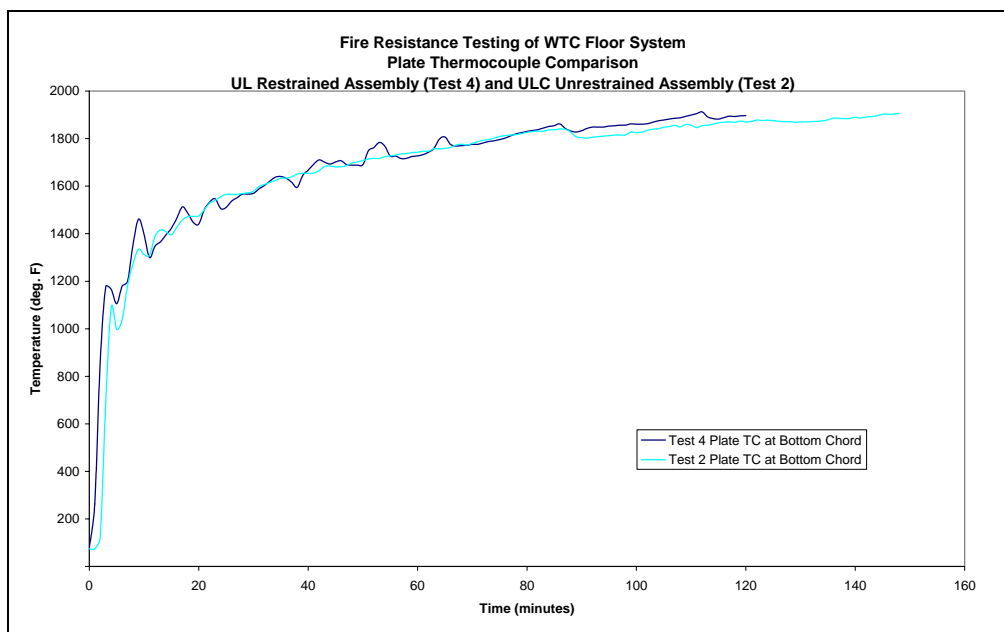

Figure 6–2. Temperatures measured at the bottom chord by the plate thermocouple in the ULC furnace (Test No. 2) and ULN furnace (Test No. 4).

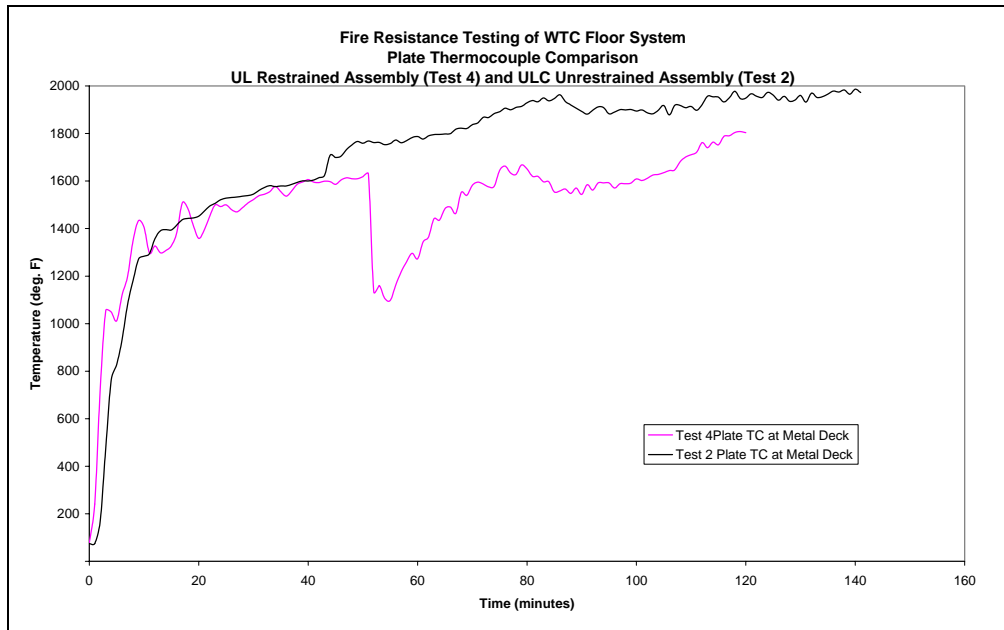

Figure 6–3. Temperatures measured at the underside of the metal deck by the plate thermocouple at the ULC furnace (Test No. 2) and ULN furnace (Test No. 4).

Radiometer Measurements

Thermal radiation is the dominant mode of heat transfer from the furnace to the test specimen. Hence, heat flux measured by radiometers should provide a better indication of how quickly a specimen will heat up than temperature of the surrounding gas as measured by furnace control thermocouples. Comparing the radiant flux measured in the larger (ULC) furnace (see Figs. 5–11 and 5–12) to the radiant heat flux measured in the smaller (ULN) furnace (see Figs. 5–48, 5–49, and 5–65), one observes that smaller furnace produced a radiant heat flux somewhat higher than the larger furnace, in spite of the fact that the temperatures used to control both furnaces followed the ASTM E 119 time-temperature curve (Fig. 6–1). Comparison of overall average temperatures of the main trusses, protected with 3/4 in. fireproofing (see Figs. 5–3, 5–24, and 5–40) indicates that, at 60 minutes, average steel temperatures are on the order of 700 °F to 800 °F for all three test specimens (furnace temperature at 60 min is prescribed to be 1700 °F).

The above observations are based on a limited number of measurements, and, for Test No. 2, there were no radiometer readings due to damage to the radiometers in Test No. 1. In addition, factors such as heat loss must also be taken into account when comparing differences in furnace exposures to assess reproducibility of test results.

6.1.3 Steel Temperatures

Steel temperatures were recorded at several locations on the main and bridging trusses. Average temperatures of the bottom chord, web diagonal, and top chord are presented here.

Figure 6–4 shows a comparison of the average temperature of the bottom chord for the three tests in which the thickness of the SFRM was $\frac{3}{4}$ in. Temperatures are seen to be very comparable up to about 75 min, which is around the time when SFRM began to dislodge.

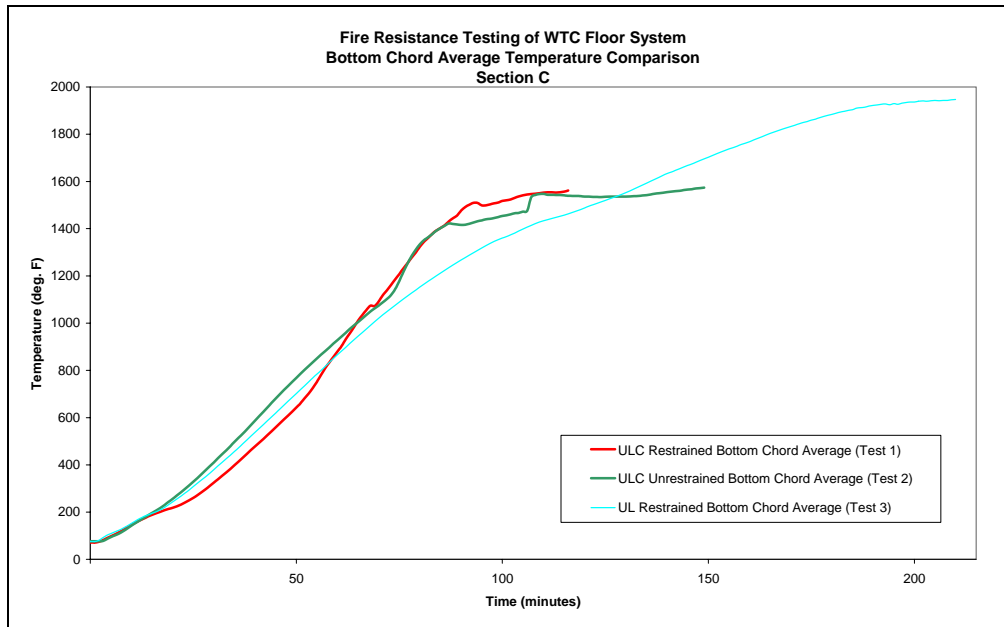

Figure 6–4. Average temperatures of the bottom chord for Test Nos. 1, 2, and 3 (3/4 in. thick SFRM).

Figure 6–5 presents a comparison of temperatures of the truss web diagonals for the three tests in which the thickness of the SFRM was $\frac{3}{4}$ in. The web temperatures for the two full-scale tests (35 ft span assemblies) were greater than those for the reduced-scale test (17 ft span assembly) after about 15 min. The reason for this difference is not clear but is possibly due to the relationship between the SFRM thickness and scale of the steel trusses. Comparison of Figs. 5–35 and 5–53 illustrates the difference in the buildup of SFRM at the intersections of the webs and chord members between the full- and reduced-scale test specimens, which may affect the rate of heating of the truss web diagonals. These results illustrate that thermal scaling is an issue that needs to be addressed.

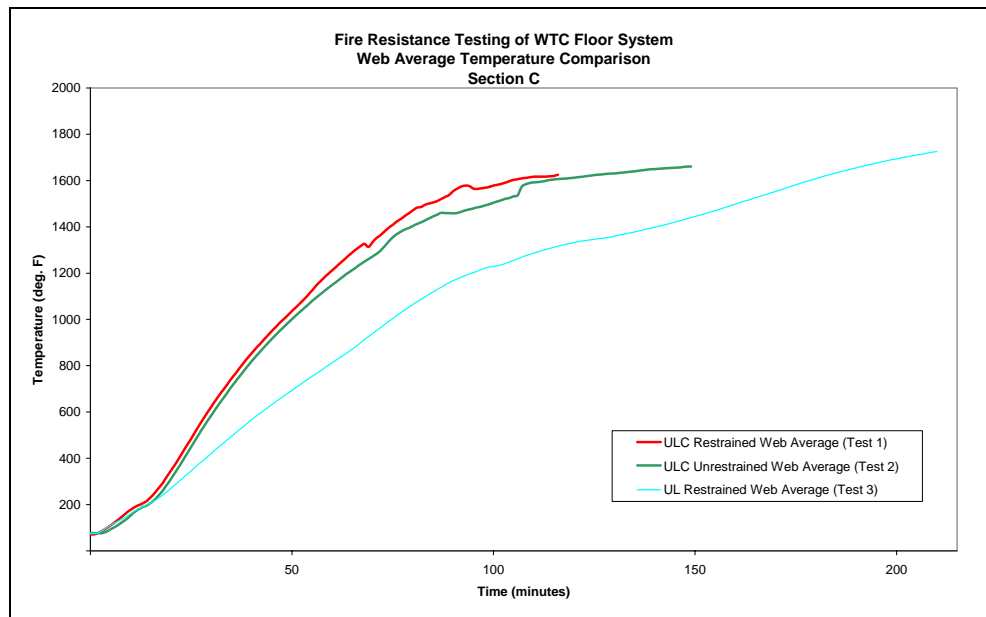

Figure 6–5. Average temperature of web diagonals for Test Nos. 1, 2, and 3 (3/4 in. thick SFRM).

The average temperature of the top chord is plotted in Figure 6–6 for the three test assemblies with $\frac{3}{4}$ in. of SFRM. The average top chord temperature for the two full-scale tests (35 ft span test assemblies) was greater than the average temperature recorded for the reduced-scale test (17 ft span assembly) after about 50 min. Because of the comparatively abrupt changes in average temperature beginning around 50 min, the difference may be explained by sudden changes such as the onset of spalling of concrete and attendant loss of fire protection. However, since the steel temperatures in the reduced-scale test generally tend to be lower than in the full-scale test, this trend may be explained by a scale-related factor such as the difference in the buildup of SFRM affecting the rate of heating of the steel as noted above. Further, it is possible that the overspray on the metal deck was greater for test Specimen No. 3 than for the other two tests since the lower chord is closer to the metal deck. This, too, would be a geometrical scaling effect.

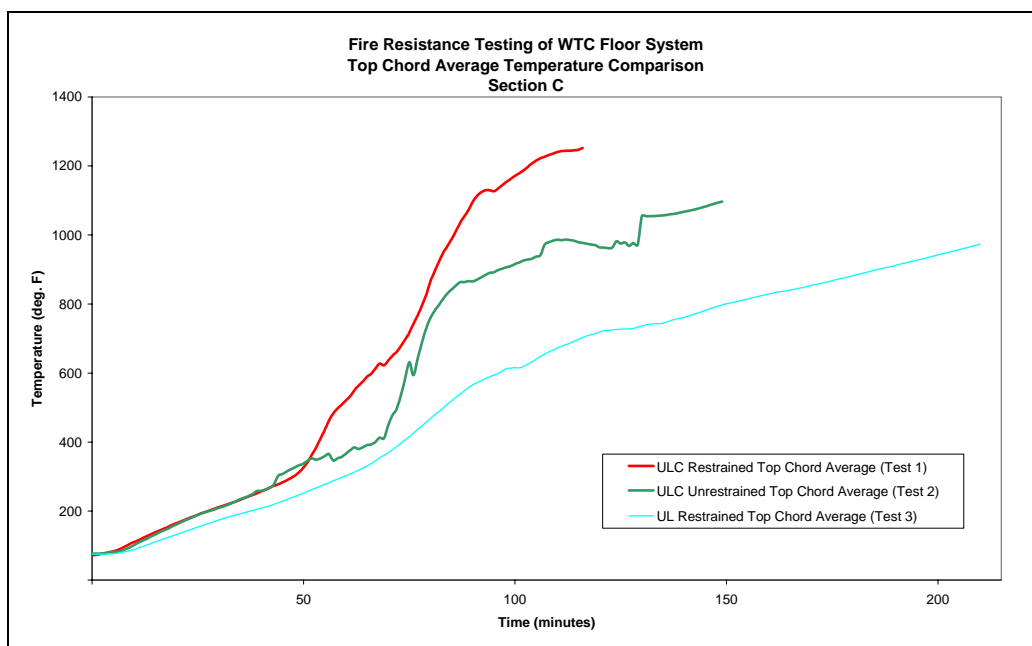

Figure 6–6. Average temperature of the top chord for Test Nos. 1, 2, and 3 (3/4 in. thick SFRM).

Average temperature of the bottom chord at Section C (center of west truss) for Test No. 3 ($\frac{3}{4}$ in. thick SFRM) and Test No. 4 ($\frac{1}{2}$ in. thick SFRM) is plotted in Fig. 6–7. As expected, the steel temperatures for the specimen with $\frac{1}{2}$ in. of SFRM were higher than those for the specimen with $\frac{3}{4}$ in. of SFRM. Here, the same furnace (ULN) was used for the comparison.

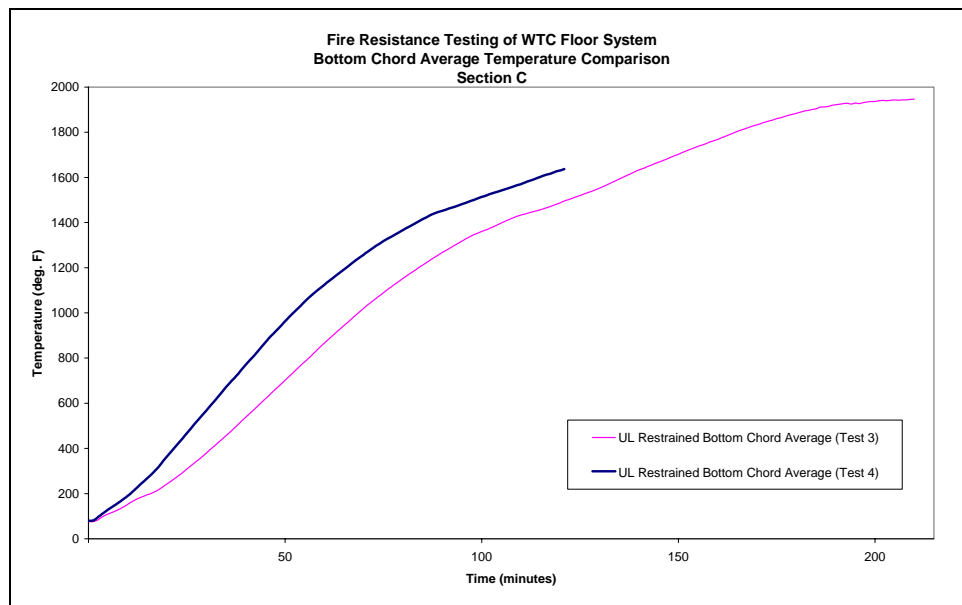

Figure 6–7. Average temperature of the bottom chord for Test No. 3 ($\frac{3}{4}$ in. thick SFRM) and No. 4 ($\frac{1}{2}$ in. thick SFRM).

6.1.4 Unexposed Surface Temperatures

The temperature of the unexposed surface of the floor assemblies is plotted in Fig 6–8. It is observed that the unexposed surface temperatures of all four test assemblies were similar prior to the onset of significant concrete spalling at around 50 min. In Test 4, the surface-mounted TC on the west edge near the center of the span was affected by the explosive failure of the slab and recorded hot gas temperatures.

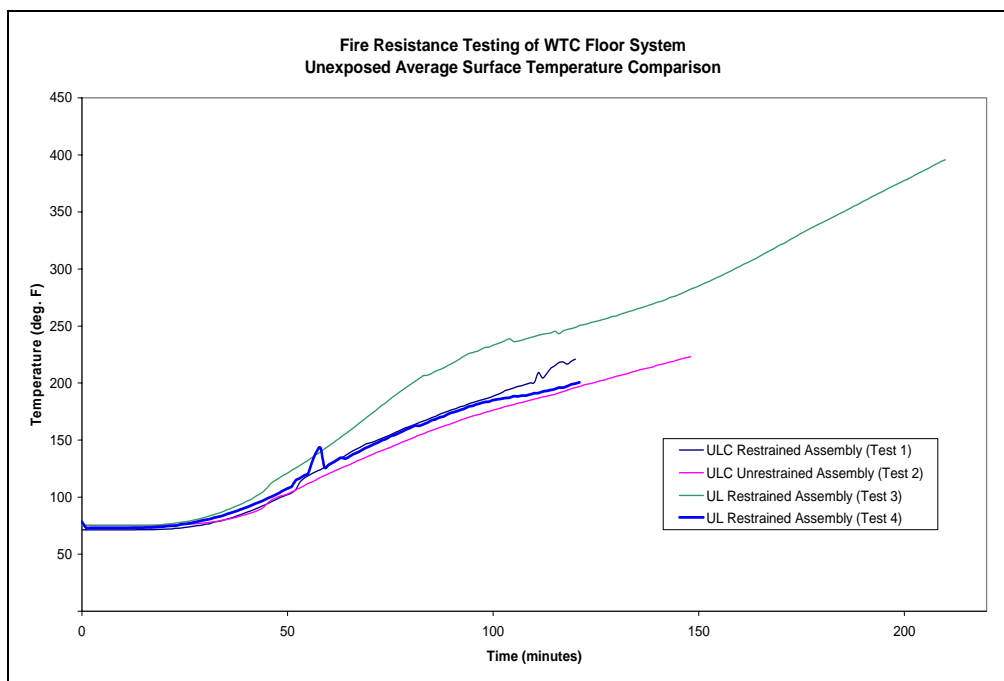

Figure 6–8. Average temperature of the unexposed surface for all four tests.

6.1.5 Deflections of Floor Assembly

The following plots show the vertical deflection measured at the center of each assembly. Figure 6–9 shows the deflection, while Fig. 6–10 shows a plot of the deflection normalized by the span. It is seen that test Assembly No. 1 experienced a significant increase in vertical deflection at 49 min, which corresponds directly to a loud report and visible deflection noted in the test observations. Figure 5–13 shows the damage to the top side of the concrete slab that occurred with the sudden increases in deflection. The normalized curves show good agreement throughout the duration of the tests.

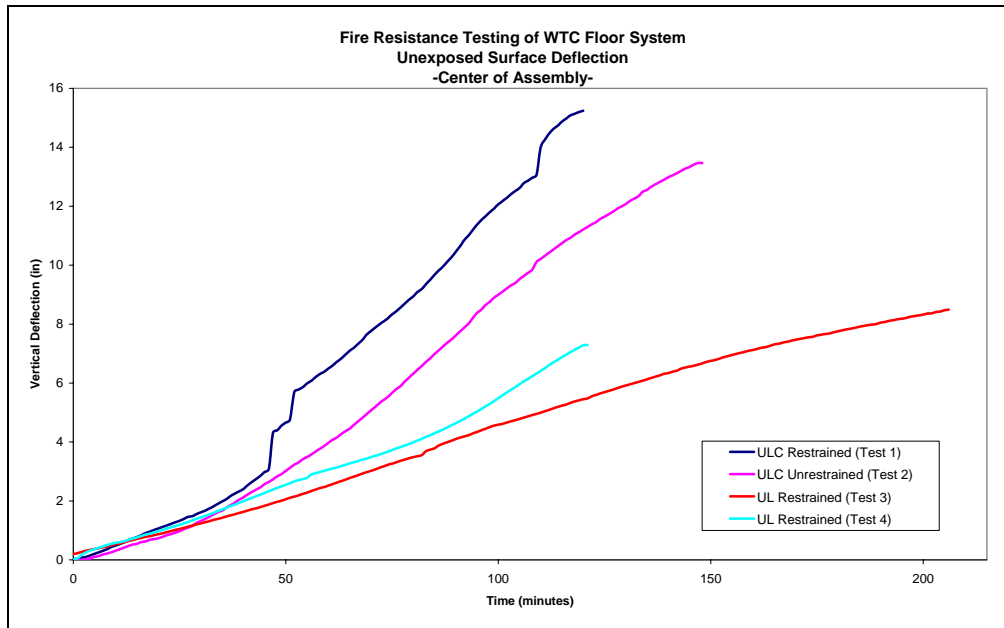

Figure 6–9. Deflection measured at the center of each assembly.

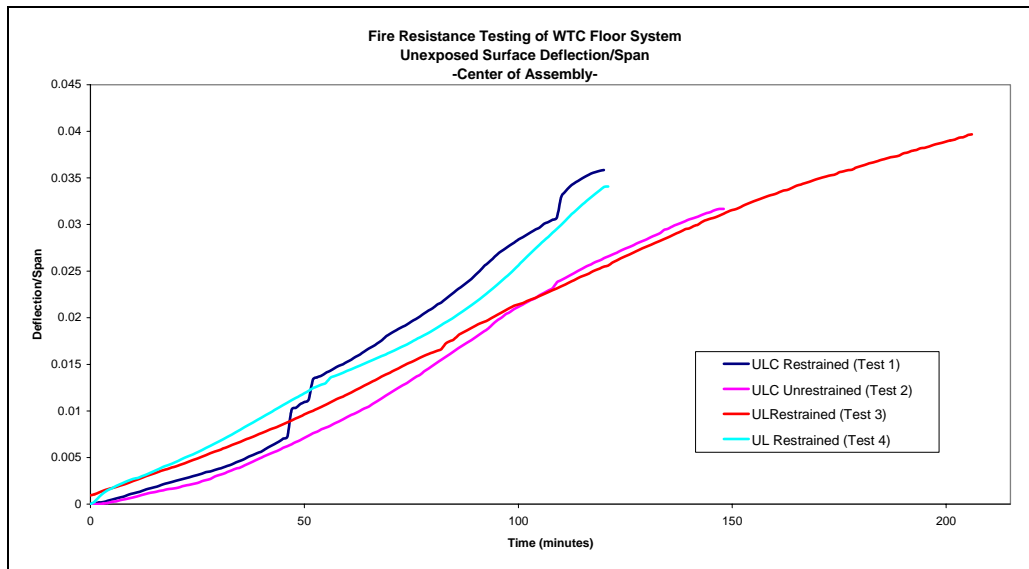

Figure 6–10. Deflection measured at the center of each assembly divided by the span.

6.2 OBSERVATIONS

Several observations can be made from the results presented in Chapter 5 for each test, the summary table of hourly ratings (Table 5–5), and the comparisons discussed above.

- The test assemblies were able to withstand standard fire conditions for between $\frac{3}{4}$ h and 2 h without exceeding the limits prescribed by ASTM E 119.

- Test specimens protected with $\frac{3}{4}$ in. thick sprayed fire-resistive material were able to sustain the maximum design load for approximately 2 hours (the minimum was 116 min) without collapsing; in the reduced-scale restrained test, the load was maintained for $3\frac{1}{2}$ h (210 min) without collapsing.
- The restrained full-scale floor system obtained a fire resistance rating of $1\frac{1}{2}$ h while the unrestrained floor system achieved a 2 h rating. Past experience with the ASTM E 119 test method would lead investigators to expect that the unrestrained floor assembly would not perform as well as the restrained assembly, and therefore, would receive a lower fire rating.
- A fire rating of 2 h was determined from the reduced-scale restrained test with the average applied SFRM thickness of $\frac{3}{4}$ in., while a fire rating of $1\frac{1}{2}$ h was determined from the full-scale restrained test with the same SFRM thickness.
- The result stated above raises the question of whether or not a fire rating based on the ASTM E 119 performance of a 17 ft span floor assembly is scalable to a larger floor system such as that found in the WTC towers where spans ranged from 35 ft to 60 ft.
- A fire rating of $\frac{3}{4}$ h was determined from the reduced-scale restrained test with the specified SFRM thickness of $\frac{1}{2}$ in.

6.3 AREAS OF FURTHER STUDY

The NIST tests have identified areas where further study related to the Standard Fire Resistance Test method may be warranted. The issues related to the test method that NIST considered in formulating its recommendations include:

- Criteria for determining structural limit states, including failure, and means for measurement
- Scale of test assembly versus prototype application
- Effect of end restraint conditions (restrained and unrestrained) on test results, including the influence of stiffness
- Structural connections (not currently addressed in ASTM E 119)
- Combination of loading and exposure (temperature profile) adequately represent expected conditions
- Procedures to analyze and evaluate data from fire resistance tests of other building components and assemblies to qualify an untested building element
- Repeatability of test results (single test currently defines rating for system)
- Reproducibility of heat flux environment between different furnaces and laboratories.
- Relationships between prescriptive ratings and performance of the assembly in realistic building fires.

Chapter 7

REFERENCES

- ACI 318-63 (1963). *Building Code Requirements for Reinforced Concrete*, American Concrete Institute, Detroit, MI.
- AISC 1963 (1963). *Manual of Steel Construction*, Sixth Edition, American Institute of Steel Construction, Chicago, IL.
- AISC 2001 (1989). *Manual of Steel Construction: Allowable stress Design*, Ninth Edition, American Institute of Steel Construction, Chicago, IL.
- AISC 2001 (2001). *Manual of Steel Construction: Load and Resistance Factor Design*, Third Edition, American Institute of Steel Construction, Chicago, IL.
- ASTM (1973). *Standard Test Methods for Fire Tests of Building Construction and Materials*, ASTM E 119-73, ASTM International, Conshohocken, PA.
- ASTM (2000). *Standard Test Methods for Fire Tests of Building Construction and Materials*, ASTM E 119-00, ASTM International, Conshohocken, PA.
- ASTM (2000a). *Standard Test Methods for Thickness and Density of Sprayed Fire-Resistive Material (SFRM) Applied to Structural Members*, ASTM E 605-93 (Reapproved 2000), ASTM International, Conshohocken, PA.
- Beitel, J, and Iwankiw, N. (2002). "Analysis of Needs and Existing Capabilities for Full-Scale Fire Resistance Testing," NIST GCR 02-843, National Institute of Standards and Technology, Gaithersburg, MD.
- Jefferson, T. B. and Woods, G. (1962). *Metals and How to Weld Them*, Second edition, The James F. Lincoln Arc Welding Foundation, Cleveland, OH.

This page intentionally left blank.

Appendix A
CERTIFIED MILL TEST REPORTS (CMTRs)

This page intentionally left blank.



BAYOU STEEL CORPORATION
 RIVER ROAD P.O. BOX 5000
 LA PLAC, LOUISIANA 70068-1156
 Telephone (985) 652-4500

MATERIAL CERTIFICATION REPORT

THE A588 & A572 STEEL CO
 133 SABAGO LAKE DRIVE
 SEWICKLY, PA 15143

THE A588 & A572 STEEL CO
 10 ARCH STREET EXT.
 CARNEGIE, PA 15106

Metals USA 9239
 PO# BA821

TESTED IN ACCORDANCE WITH **ASTM A6** INVOICE NO. **09/17/03** DATE
 PRODUCT ANGLES **Cust A-0005 -0000**
 HEAT NO. **18040S 83 POS** GRADE **A588B -01**
 Length **40'0"** SIZE **L 2 X 2 X 1/4 X 3.19**

CHEMICAL ANALYSIS	TEST 1		TEST 2		TEST 3	
	IMPERIAL	METRIC	IMPERIAL	METRIC	IMPERIAL	METRIC
C	.16					
Mn	.94					
P	.008					
S	.03					
Si	.25					
Cu	.37					
Ni	.13					
Cr	.50					
Mg	.045					
Cb	.000					
V	.035					
B						
Al						
Sn						
N						
Ti						

MECHANICAL PROPERTIES	TEST 1		TEST 2		TEST 3	
	IMPERIAL	METRIC	IMPERIAL	METRIC	IMPERIAL	METRIC
YIELD STRENGTH	61,245 PSI	422 MPa	62,178 PSI	429 MPa		
TENSILE STRENGTH	92,502 PSI	638 MPa	92,389 PSI	637 MPa		
ELONGATION	30.0 %	30.0 %	25.0 %	25.0 %		
GAUGE LENGTH	8 in	203 mm	8 in	203 mm		
BEND TEST DIAMETER	d	d	d	d		
BEND TEST RESULTS	sq in	sq mm	sq in	sq mm		
SPECIMEN AREA	%	%	%	%		
REDUCTION OF AREA	fr-lbs	J	fr-lbs	J		
IMPACT STRENGTH						

Customer Grade & Specs: **A588B** NO WELD REPAIR
AASHTO M270 GRADE 50W, 345MPa, ASTM GRADE A572 GRADE 50
FULLY KILLED FINE GRAIN PRACTICE

I HEREBY CERTIFY THAT THE MATERIAL TEST RESULTS PRESENTED HERE ARE FROM THE REPORTED HEAT AND ARE CORRECT. ALL TESTS WERE PERFORMED IN ACCORDANCE TO THE SPECIFICATIONS REPORTED ABOVE. ALL STEEL IS ELECTRIC FURNACE MELTED, MANUFACTURED, PROCESSED, AND TESTED IN THE U.S.A WITH SATISFACTORY RESULTS, AND IS FREE OF MERCURY CONTAMINATION IN THE PROCESS.

NOTARIZED UPON REQUEST:
 SWORN TO AND SUBSCRIBED BEFORE ME IN AND FOR ST. JOHN
 PARISH ON THIS _____ DAY OF _____, 20____

SIGNED
 TIMOTHY R. WEIDE, QUALITY ASSURANCE MANAGER

DIRECT ANY QUESTIONS OR NECESSARY CLARIFICATIONS CONCERNING
 THIS REPORT TO THE SALES DEPARTMENT.

1-800-635 7692 (USA)

NOTARY PUBLIC



ROANOKE ELECTRIC STEEL CORPORATION

P.O. BOX 13948

ROANOKE, VIRGINIA 24038-3948

Test and Inspection Report

NO. 47405-1

ROANOKE

METALS USA P&S LANGHORNE

50 CABOT BOULEVARD
LANGHORNE PA 19047-0000

Date 3/05/03

HEAT NUMBER	SIZE	1-YIELD Pt. KSI	ULTIMATE KSI	ELONG 8 IN.	BEND TEST	GRADE				
JD4165	ANGLES 1 1/2 X 1 1/2 X 1/4	61.7	79.2	23.1		AH36				
PURCHASE ORDER NUMBER	NUMBER PIECES	2-YIELD PT. KSI	ULTIMATE KSI	ELONG 8 IN.	BEND TEST	GRADE				
W6095	251 PIECES 20'	63.4	80.7	23.1		AH36				
HEAT NUMBER	SIZE	1-YIELD Pt. MPA	ULTIMATE MPA	ELONG 203mm	BEND TEST	GRADE				
JD4165	ANGLES 38.1 X 38.1 X 6.4	425.4	546.1	23.1		AH36				
PURCHASE ORDER NUMBER	NUMBER PIECES	2-YIELD PT. MPA	ULTIMATE MPA	ELONG 203mm	BEND TEST	GRADE				
W6095	251 PIECES 20'	437.1	556.4	23.1		AH36				
C	MN	S	P	SI	CR	NI	MO	CU	V	NB
.15	1.10	.020	.008	.21	.08	.09	.02	.24	.060	.001



Manufactured Heavy Carbon Steel

Test Reports for

CANAM

Work Order # R6517

Requisition #

Our Invoice # PH-60047

MERCURY, RADIUM OR OTHER ALPHA SOURCE MATERIALS IN ANY FORM HAVE NOT BEEN USED IN THE PRODUCTION OF THIS MATERIAL. NO WELD REPAIR HAS BEEN PERFORMED. MATERIAL MANUFACTURED IN ACCORDANCE WITH OUR QUALITY MANUAL REVISION 9 DATED 5-1-1998, BASED UPON ISO 9002-1994, ASME SECTION III DIV I NCA3800, ANSI-45.2 10CFR50 AND 10CFR21.

Approved ABS QA Mill. Certificate No. 00NN10108-X.

This material was melted and manufactured in the USA by basic Electric Furnace processes to meet specification: ASTM A572-99A GR 50 TYPE 2

The tensile values stated in either inch-pound units or SI units are to be regarded as separate as defined in the ASTM scope for this material. Unless a metric specification is ordered, this material has been tested and meets the requirements of the inch-pound ranges.

This is to certify the above to be a true and accurate report as contained in the records of this company.

Engineer of Tests: Charles R. Charlton

INSTEEL WIRE PRODUCTSDISCRETE JOB # 161663

Mount Airy, North Carolina

This is to certify that the manufacturing processes for the reinforcement material described below occurred in the United States of America and was made in accordance with and conforms to the following specifications:

ASTM -A 82 Tensile & Bend Tests
 ASTM-A 185 Weld Shear Tests

Conf Number: 164877

Cust. Order No: _____

Sales Order No: _____

Item

Number: 533-061358 Product Style: 10X4-W4.2/W4.3-60"X18'2"(1+1)
W4.2/W4.3

TENSILE TESTS

WIRE SIZES		Test No.	Pounds / Foot *Deformed Wire Only*		WIRE DIA. (Inches)	ACTUAL AREA (Sq. In.)	TENSILE POUNDS/ SQ. IN.	ROA %	YIELD STRENGTH P.S.I.
Longitudinal	Transverse		Actual	Nominal					
W4.2	XXXXXXX	1			0.230	0.04155	96,412	61%	71,361
W4.2	XXXXXXX	2			0.230	0.04155	94,450	61%	71,361
XXXXXXX	W4.3	1			0.234	0.04301	95,076	59%	72,198
XXXXXXX	W4.3	2			0.234	0.04301	96,117	59%	72,198

ALL WIRES LISTED ABOVE MEET A.S.T.M. A-82 OR A-496 BEND TEST REQUIREMENTS

WELD SHEAR TESTSWIRE SIZES: W4.2 / W4.3

Test Number	1	2	3	4
Break Load (Lbs. Of Force)	2764	2215	3608	3477

MINIMUM BREAK LOAD REQUIRED 1505 LBS. OF FORCE**RAW MATERIALS - HEAT NUMBER INFORMATION**

Longitudinal Wires	Heat No's.:
Code: W17516	164877
Transverse Wires	Heat No's.:
Code: W17516	164877

Date: 12/13/2003

Quality Assurance *David Edwards*
 Insteel Wire Products Wesley Knott

INSTEEL WIRE PRODUCTSDISCRETE JOB # 161664

Mount Airy, North Carolina

This is to certify that the manufacturing processes for the reinforcement material described below occurred in the United States of America and was made in accordance with and conforms to the following specifications:

ASTM -A 82 Tensile & Bend Tests
 ASTM-A 185 Weld Shear Tests

Conf Number: 164877

Cust. Order No: _____

Sales Order No: _____

Item

Number: 533-061359 Product Style: 10x4-W4.2/W4.3-60"(+)X36"2"(1+1)W4.2/W4.3**TENSILE TESTS**

WIRE SIZES		Test No.	Pounds / Foot *Deformed Wire Only*		WIRE DIA. (Inches)	ACTUAL AREA (Sq. In.)	TENSILE POUNDS/ SQ. IN.	ROA %	YIELD STRENGTH P.S.I.
Longitudinal	Transverse		Actual	Nominal					
W4.2	XXXXXXX	1			0.230	0.04155	96,281	61%	71,361
W4.2	XXXXXXX	2			0.230	0.04155	94,936	61%	71,361
XXXXXXX	W4.3	1			0.234	0.04301	95,169	59%	72,198
XXXXXXX	W4.3	2			0.234	0.04301	96,047	59%	72,198

ALL WIRES LISTED ABOVE MEET A.S.T.M. A-82 OR A-496 BEND TEST REQUIREMENTS

WELD SHEAR TESTSWIRE SIZES: W4.2 / W4.3

Test Number	1	2	3	4
Break Load (Lbs. Of Force)	2562	3635	3708	3608

MINIMUM BREAK LOAD REQUIRED 1505 LBS. OF FORCE**RAW MATERIALS - HEAT NUMBER INFORMATION**

Longitudinal Wires	Heat No's.:
Code: W17516	164877
Transverse Wires	Heat No's.:
Code: W17516	164877

Date: 12/13/2003
 Quality Assurance *David Edwards*
 Insteel Wire Products Wesley Knott

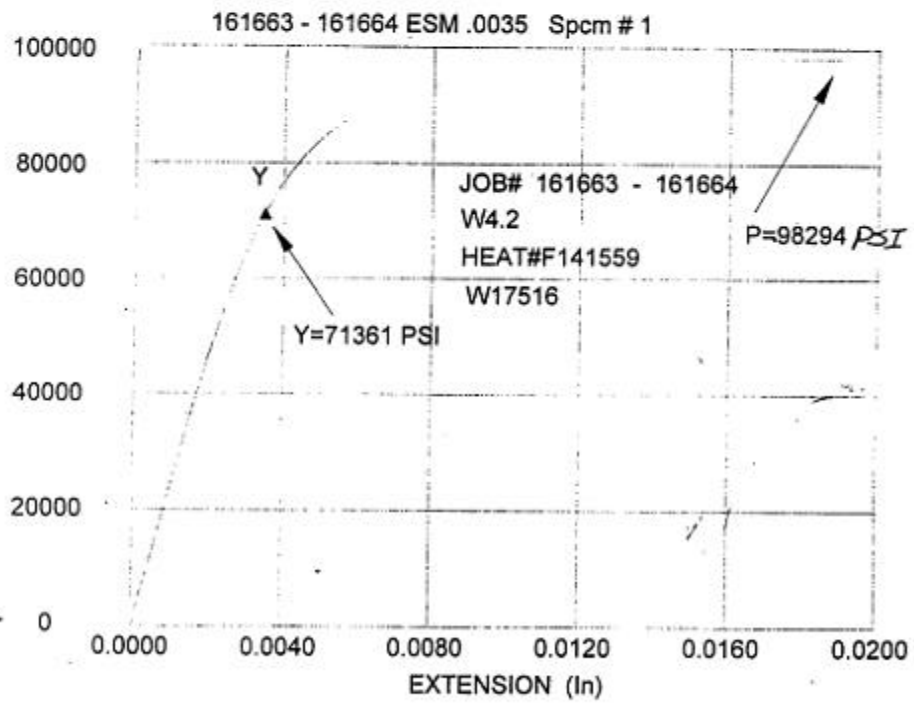

ESM 161663-161664-T Spcm # 1

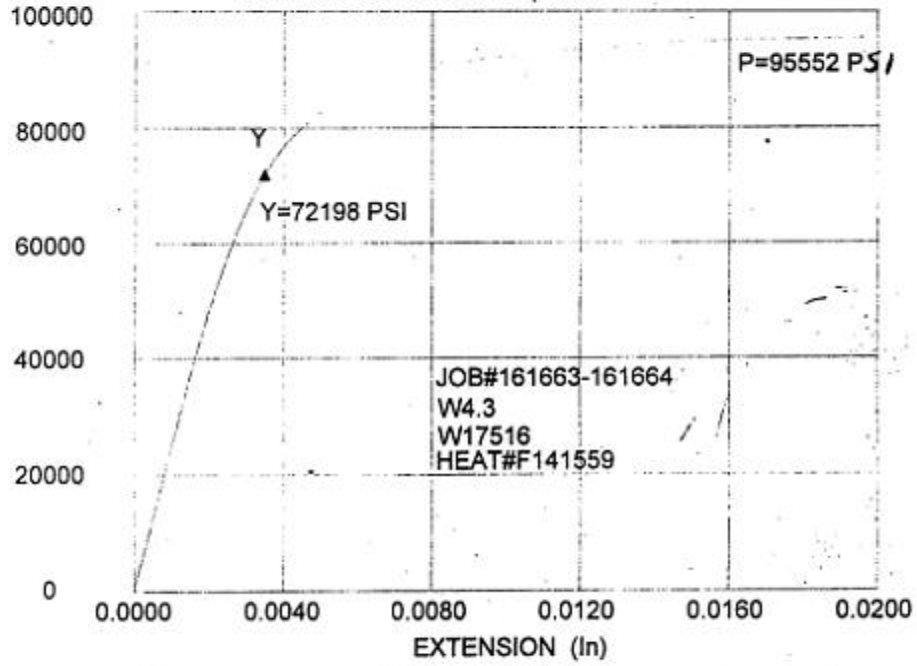

Appendix B
PRIMER PAINT SPECIFICATION

This page intentionally left blank.

September 1, 1967

Laclede Standard Steel Joist Paint
(FORMULA LREP - 10001)

Title: Standard Protective Red Chromate Primer No. 10001

Formulation:

Pigment		28.5%
Iron Oxide	55.0%	
Aluminum Silicate	41.0%	
Strontium Chromate	4.0%	
Total Pigment	100.0%	
Vehicle		71.5%
Unmodified Epoxy Amine	45.0%	
Deionized Water and Amine	55.0%	
Total Vehicle	100.0%	
		<hr/> 100.0%

Wt/Gal	9.3 Lbs.
Solids	52% by wt.
Grind	#4 Hegman Gauge
Viscosity	3600 cps. at 77° F.
Bake	Metal temperature 20 minutes at 350° F.
Weatherability	ASTM B-117-64 passes 150 hrs. on specified clean steel panel at 1 mil film thickness unscrubbed
Film Thickness	Dry 1.0 plus or minus 0.2 mils
Gloss	30 - 50
Pencil Hardness	F - H

Folder
From WTC 221.00
PAINTING

2002-NOV-20

12

July 17, 1967

RECOMMENDED PAINT SPECIFICATION

Steel Joists and Accessories

Steel joists, bridging and accessories shall receive one uniform coat of protective paint before shipment, applied by the electrophoresces or similar process, providing a dense coating with a minimum dry film thickness of one mil.

The shop paint or primer shall be furnished in accordance with Pittsburgh Plate Glass Company Standard V.C. 41901 or equal. The finish applied paint shall be subject to a ~~300~~³⁵⁰° Fahrenheit baking for a minimum of 10 minutes.

The paint shall be furnished in the manufacturer's standard red or gray color as specified.

Paint shall be applied thoroughly and evenly to clean chord angle and web sections with a resultant film not detrimental to the quality of field welding or field applied insulation or paint. The painted surfaces shall be free from oil, grease, dirt and foreign material.

The shop coating shall withstand 150 hours of 5% salt fog when applied to a clean rolled steel panel at 1.0 mil dry film thickness and tested according to ASTM B-117 salt fog test. Maximum failure allowed will be 6F according to ASTM D-714-56.

Appendix C
CONSTRUCTION DRAWINGS FOR 35 FT TEST ASSEMBLIES

This page intentionally left blank.

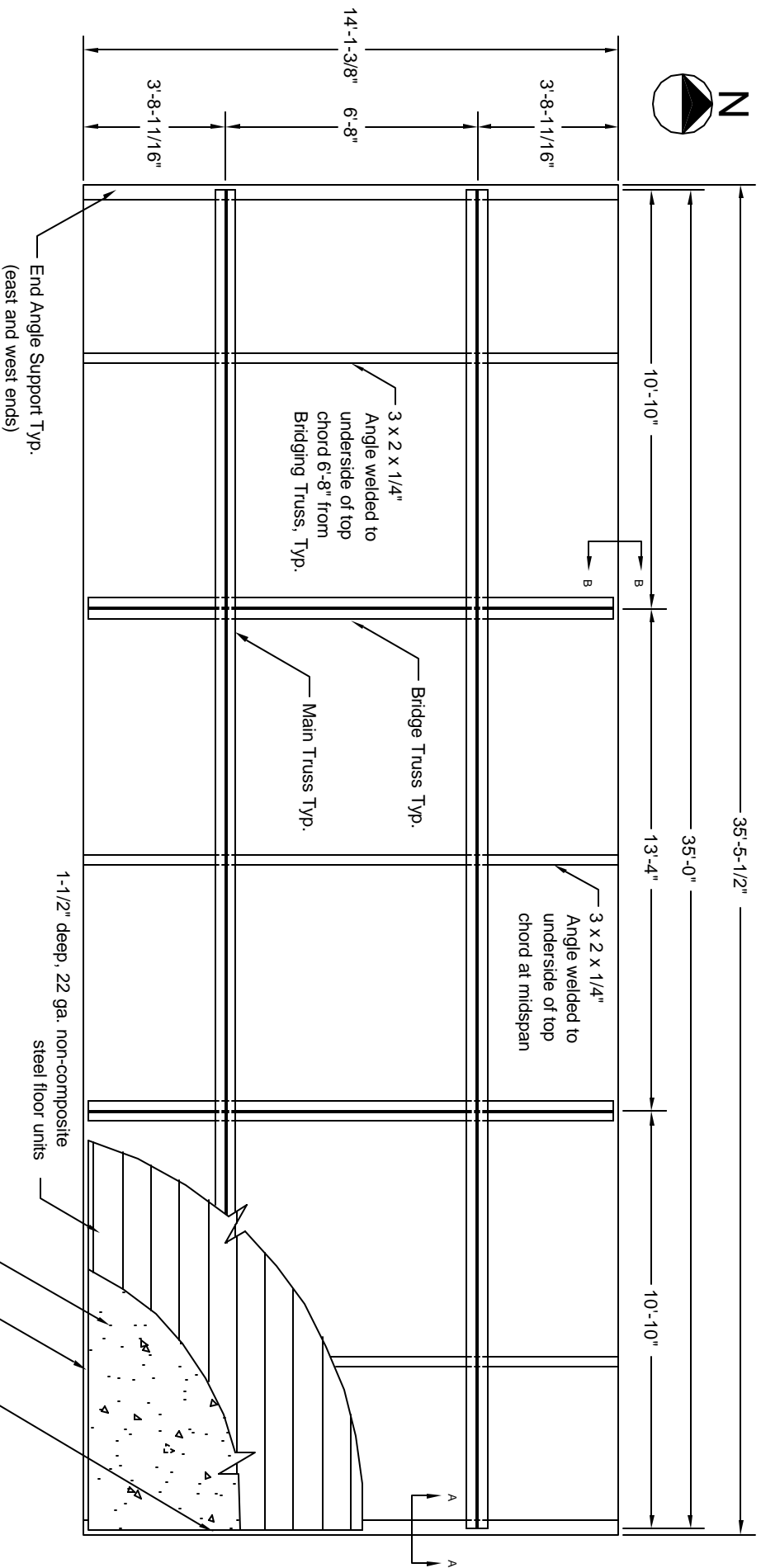

Top View

Construction Details

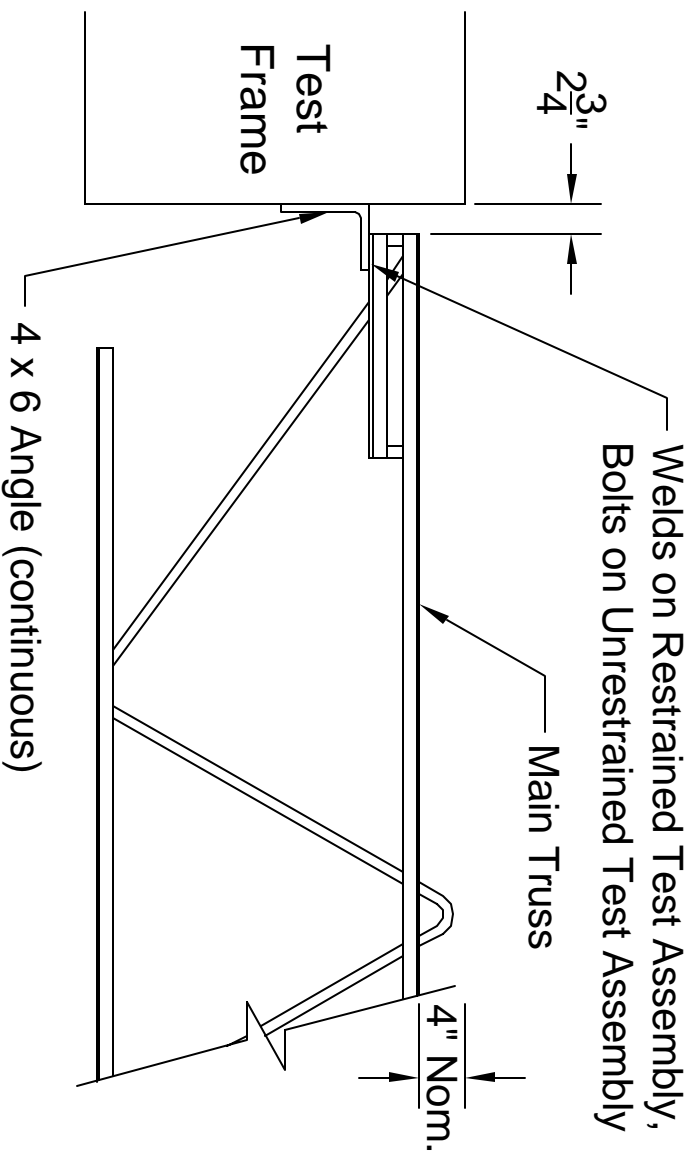

Section A-A

Construction Details

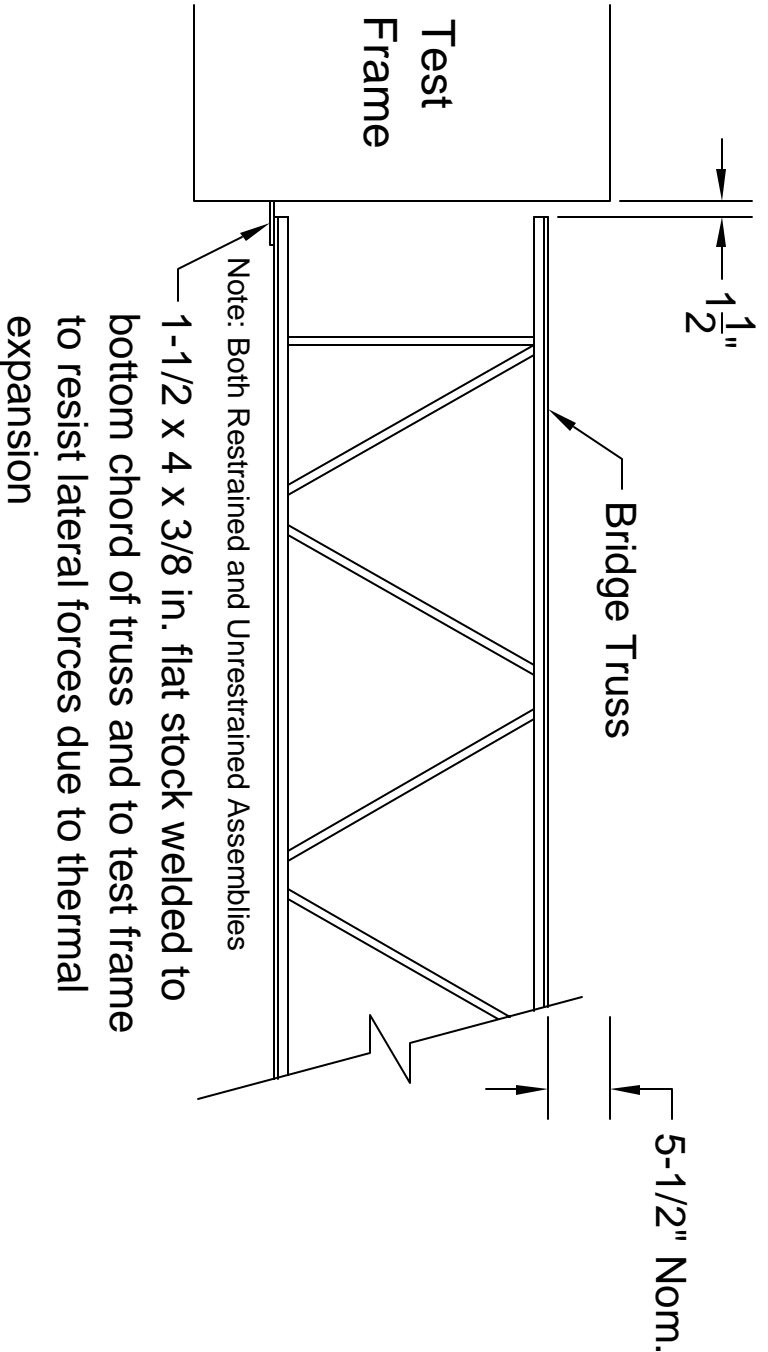

Section B-B

Construction Details

This page intentionally left blank.

Appendix D
INSTRUMENTATION FOR 35 FT TEST ASSEMBLIES

This page intentionally left blank.

					*	*	*	*	
A	B	C	D	E	F	G	H	I	J
1	9	17	25	33	41	49	59	69	79
2	10	18	26	34	42	50/51	60/61	70/71	80/81
3	11	19	27	35	43	52	62	72	82
4	12	20	28	36	44	53	63	73	83
5	13	21	29	37	45	54	64	74	84
6	14	22	30	38	46	55/56	65/66	75/76	85/86
7	15	23	31	39	47	57	67	77	87
8	16	24	32	40	48	58	68	78	88

* = Lower number to the East of the Bridging Truss and Higher number to the West of the Bridging Truss

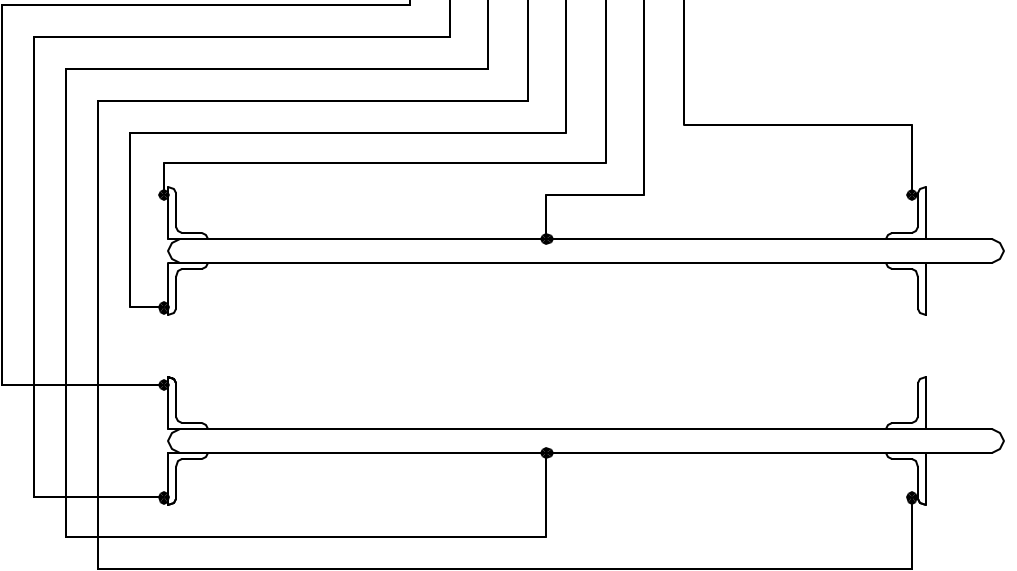

ø - 1" diameter opening for thermocouple wires on main and bridge trusses.

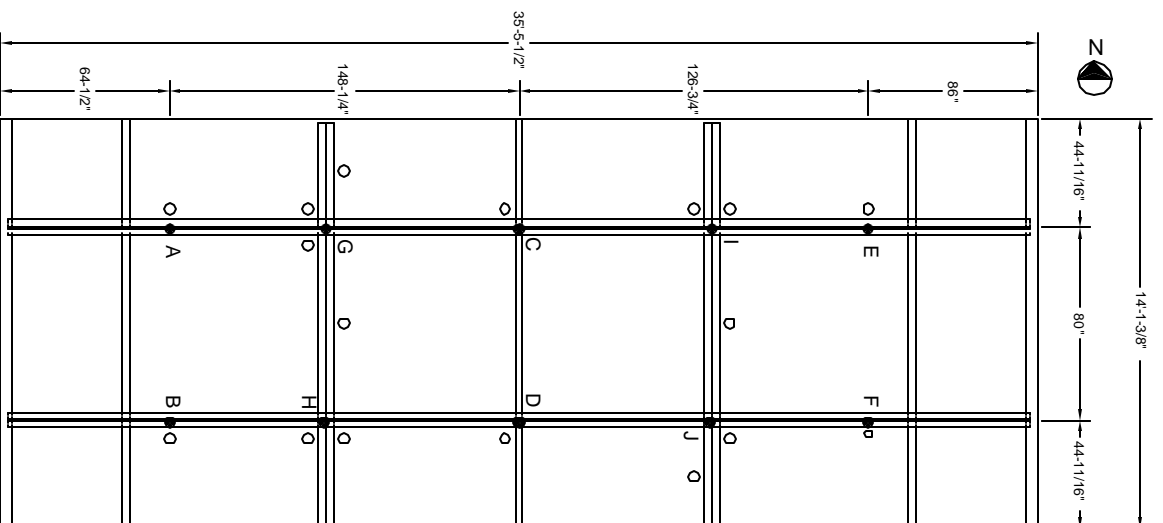

Main Truss Thermocouple Locations

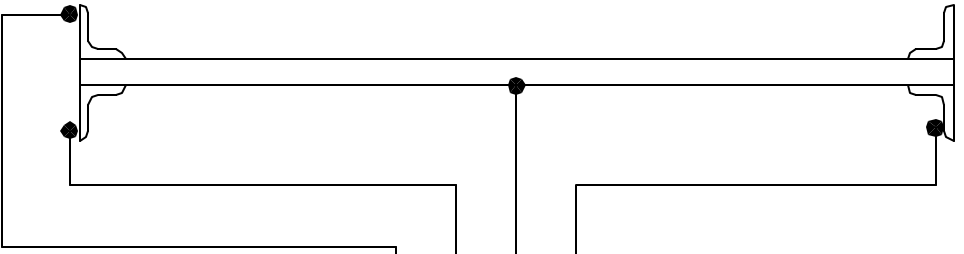

A	B	C	D	E	F	G	H
89	93	97	101	105	109	113	117
90	94	98	102	106	110	114	118
91	95	99	103	107	111	115	119
92	96	100	104	108	112	116	120

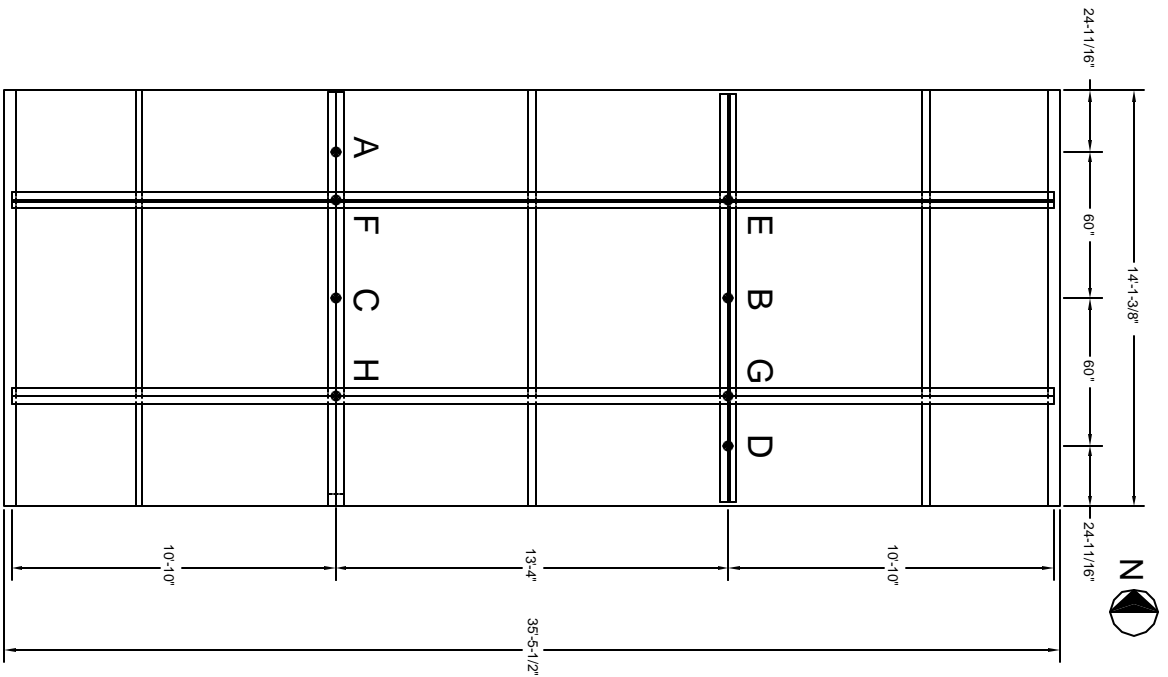

Bridging Truss Thermocouple Locations

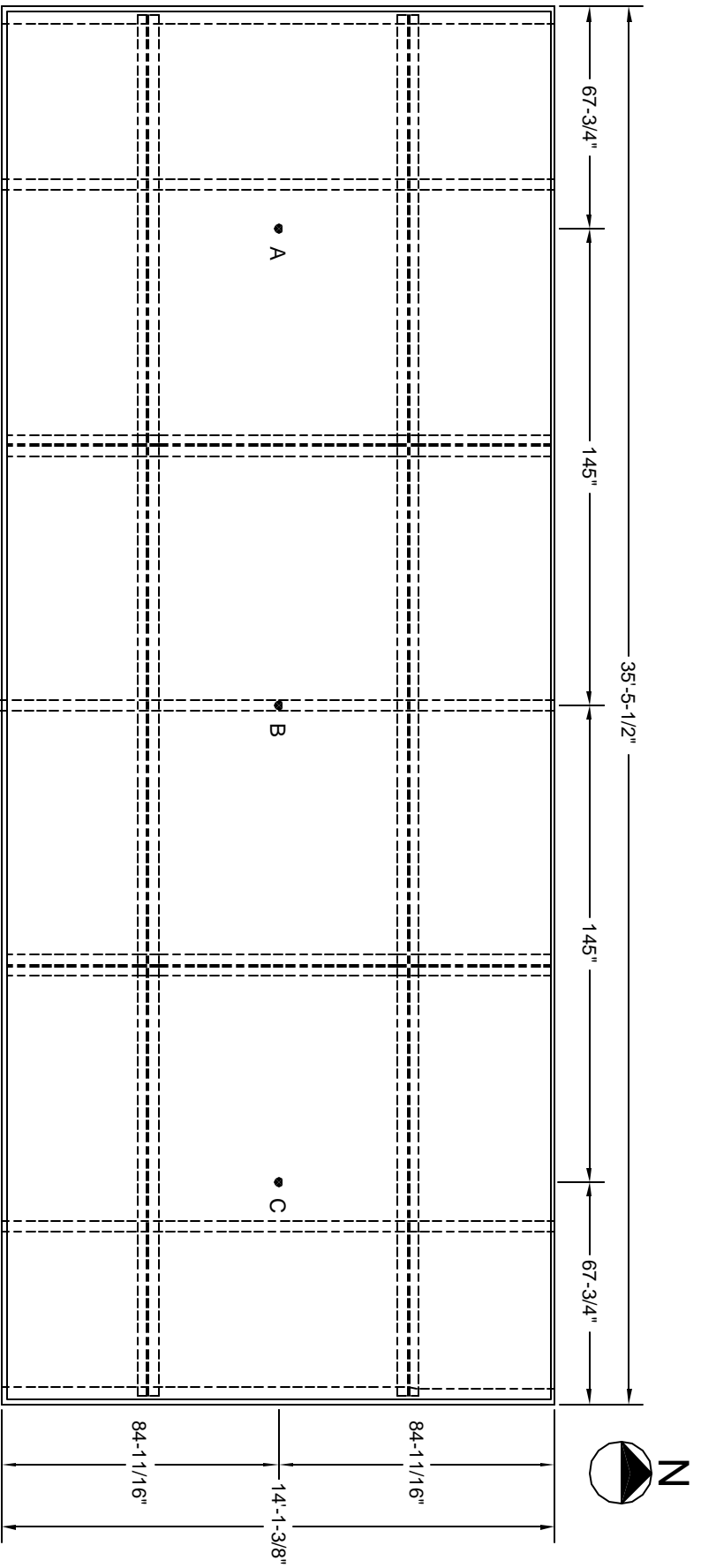

Note: Dimensions for locations may vary slightly depending on deck valley and crest occurrence in actual construction

A	B	C	
121	125	129	Joint
122	126	130	Crest
123	127	131	Side
124	128	132	Valley

Steel Deck Thermocouple Locations

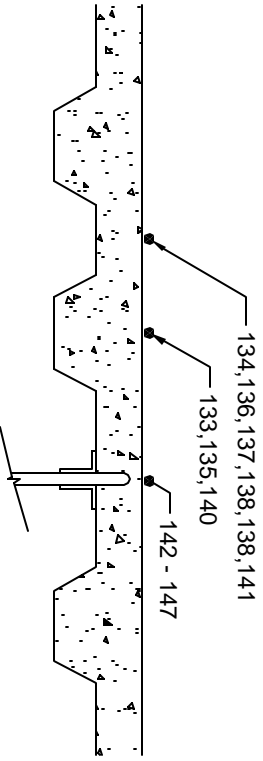
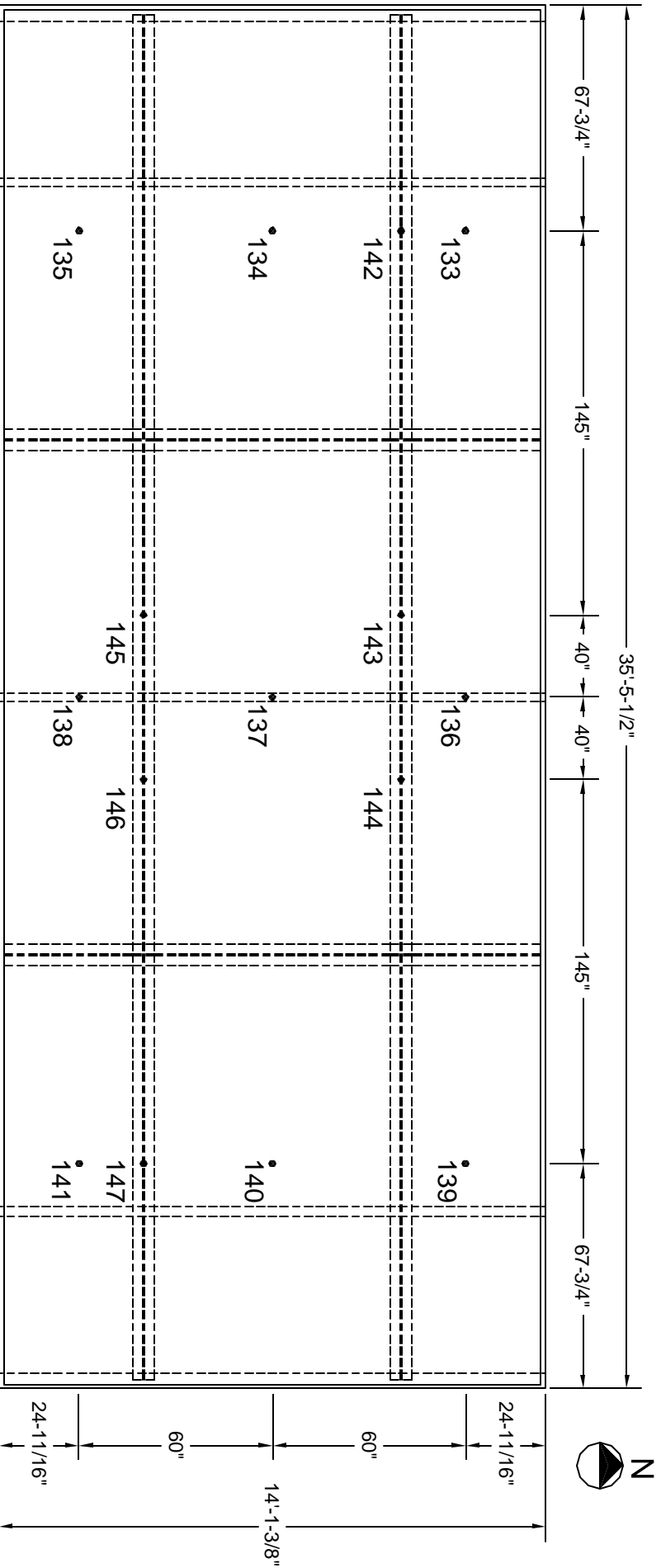

Note: Dimensions for locations may vary slightly depending on deck valley and crest occurrence, and main truss knuckle location in actual construction

Unexposed Surface Thermocouple Locations

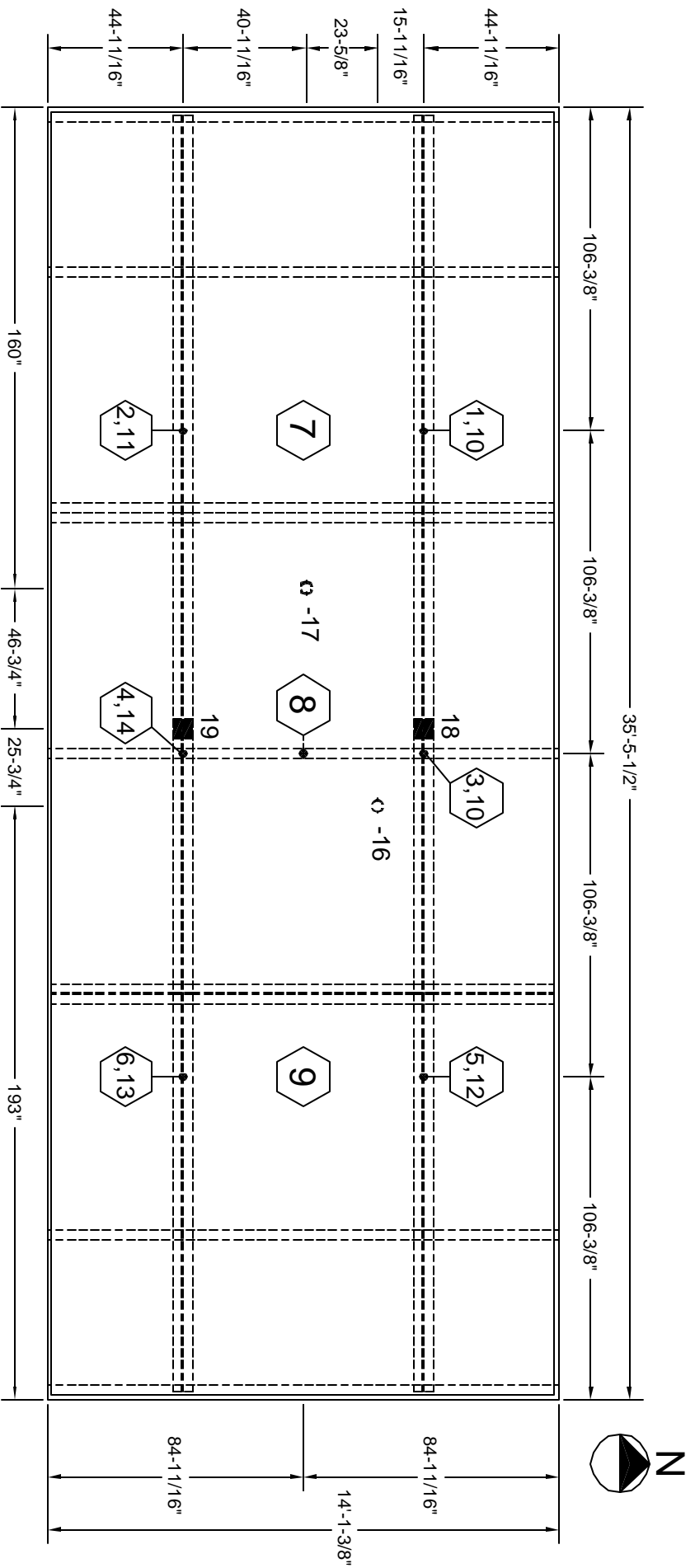

Additional Instrumentation Locations

Note: Number 17 on Test
 Assembly No. 2 was moved
 6 inches South from the
 location shown on drawing
 due to Steel Deck
 Thermocouple Locations

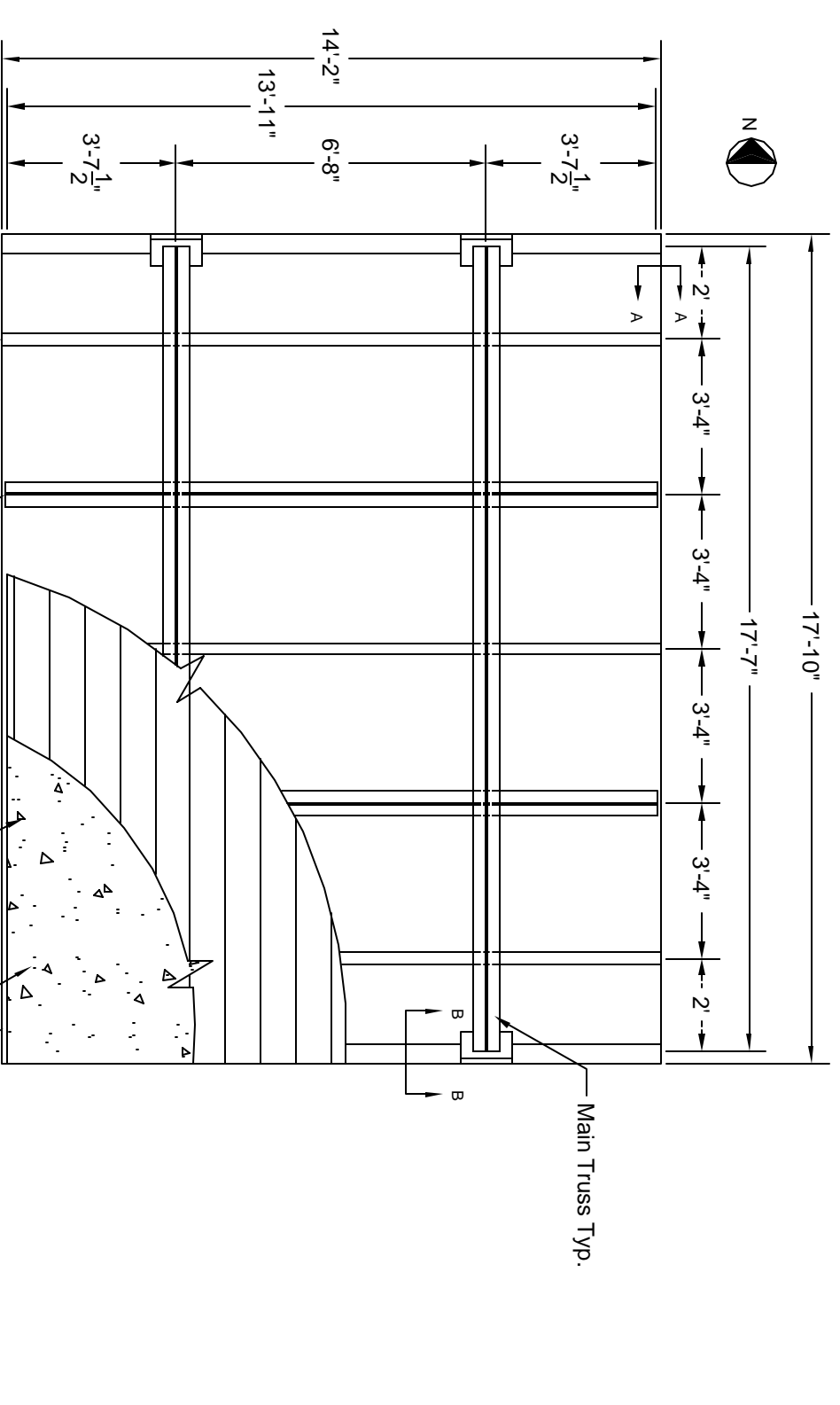

3 x 2 x 1/4" Angle welded to underside of top chord

Note: All Connections outside of fire area

Top View
Construction Details

Appendix E
CONSTRUCTION DRAWINGS FOR 17 FT TEST ASSEMBLIES

This page intentionally left blank.

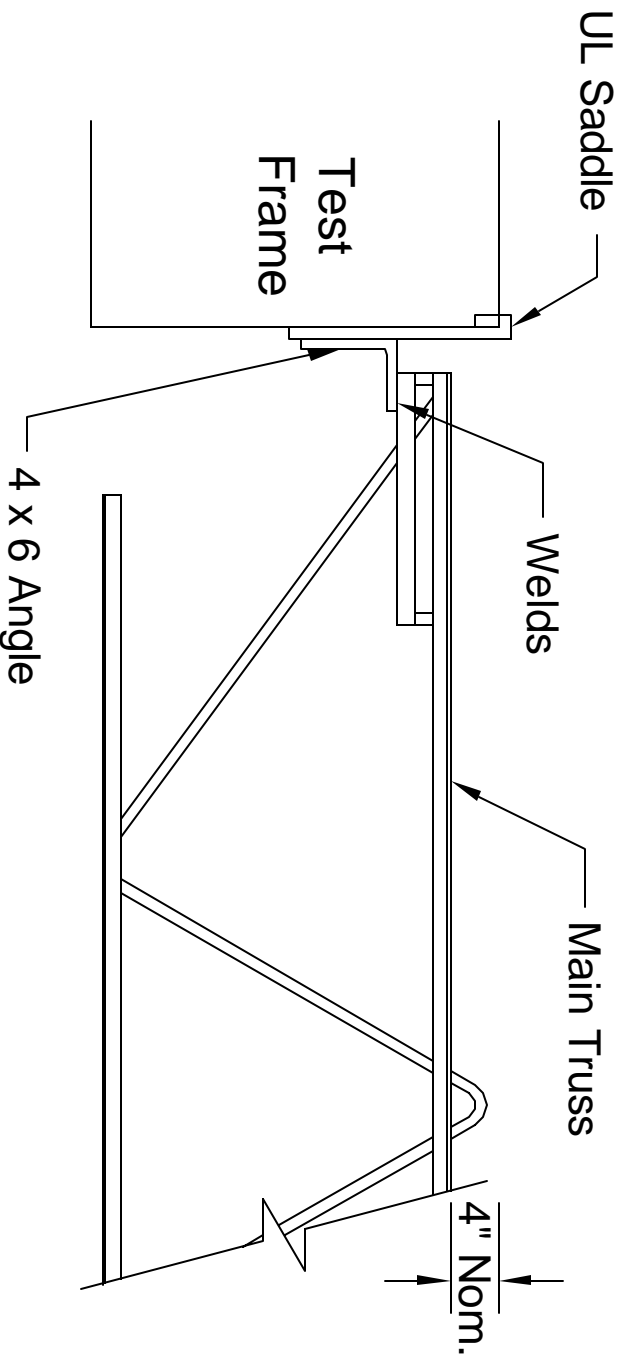

Section A-A

Construction Details

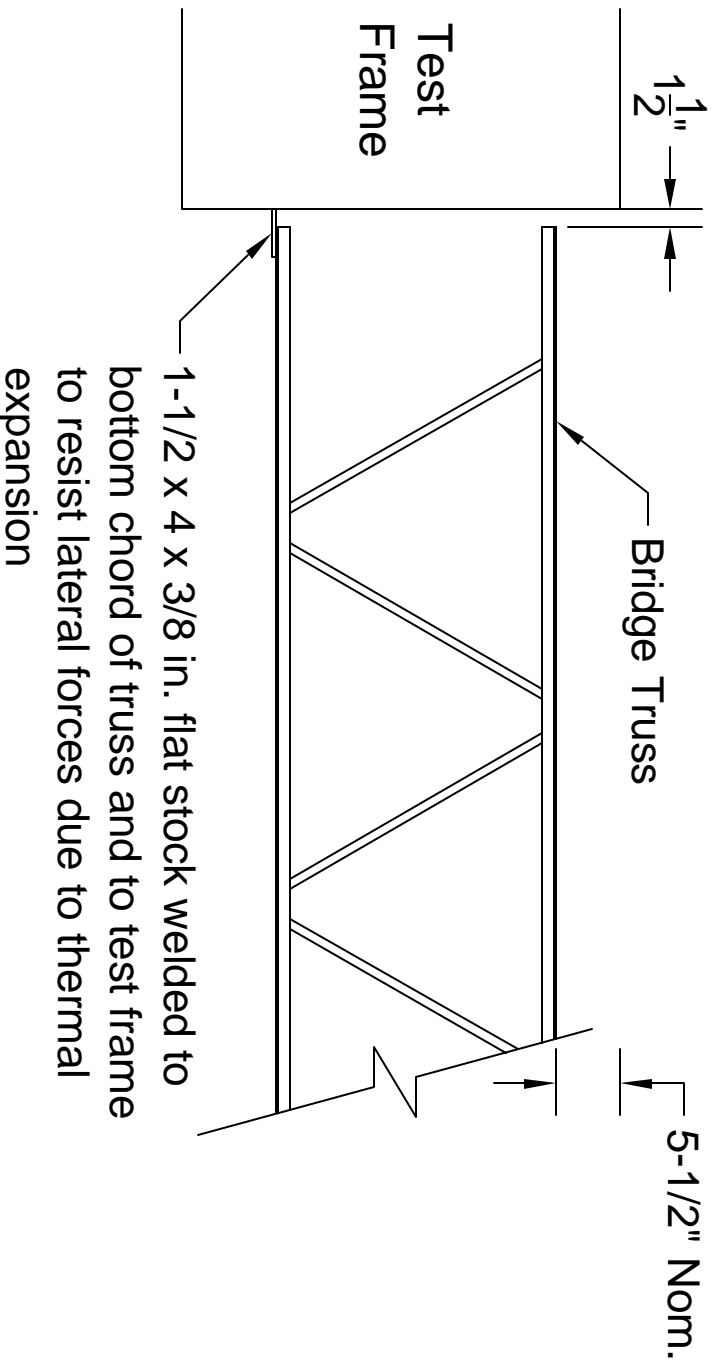

Section B-B

Construction Details

Appendix F
INSTRUMENTATION FOR 17 FT TEST ASSEMBLIES

This page intentionally left blank.

A	B	C	D	E	F	G	H	I	J
1	9	17	25	33	41	49	57	65	73
2	10	18	26	34	42	50	58	66	74
3	11	19	27	35	43	51	59	67	75
4	12	20	28	36	44	52	60	68	76
5	13	21	29	37	45	53	61	69	77
6	14	22	30	38	46	54	62	70	78
7	15	23	31	39	47	55	63	71	79
8	16	24	32	40	48	56	64	72	80

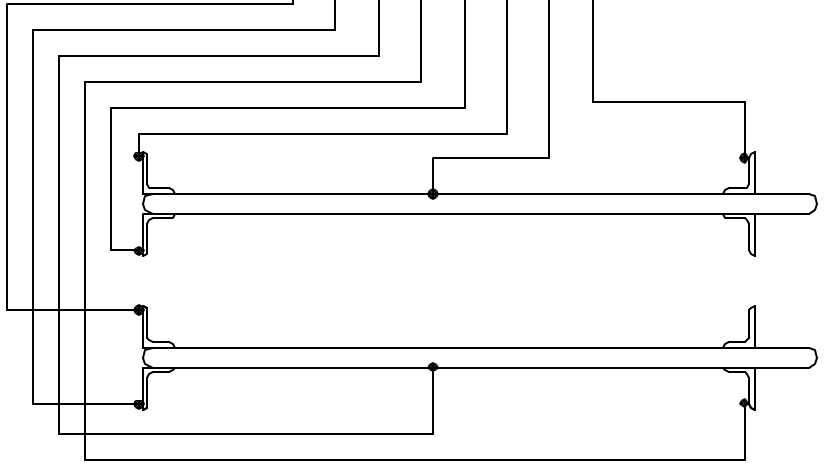

ø - 1" diameter opening for thermocouple wires on main and bridging trusses.

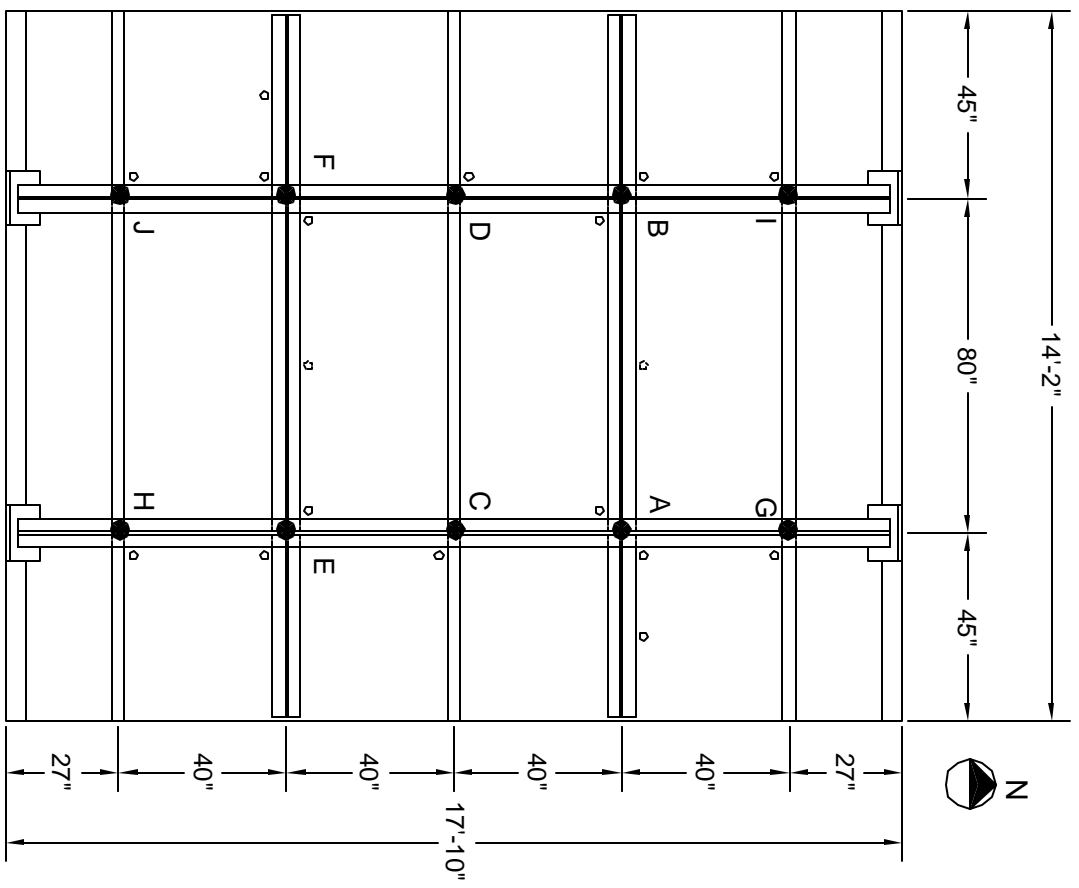

Main Truss Thermocouple Locations

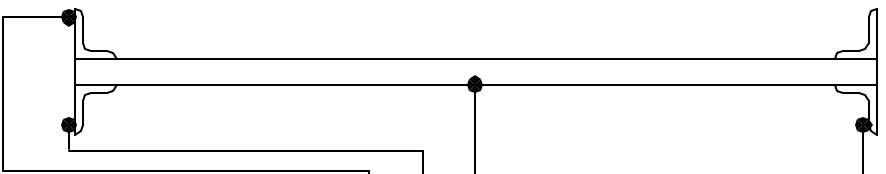

A	B	C	D	E	F	G	H
81	85	89	93	97	101	105	109
82	86	90	94	98	102	106	110
83	87	91	95	99	103	107	111
84	88	92	96	100	104	108	112

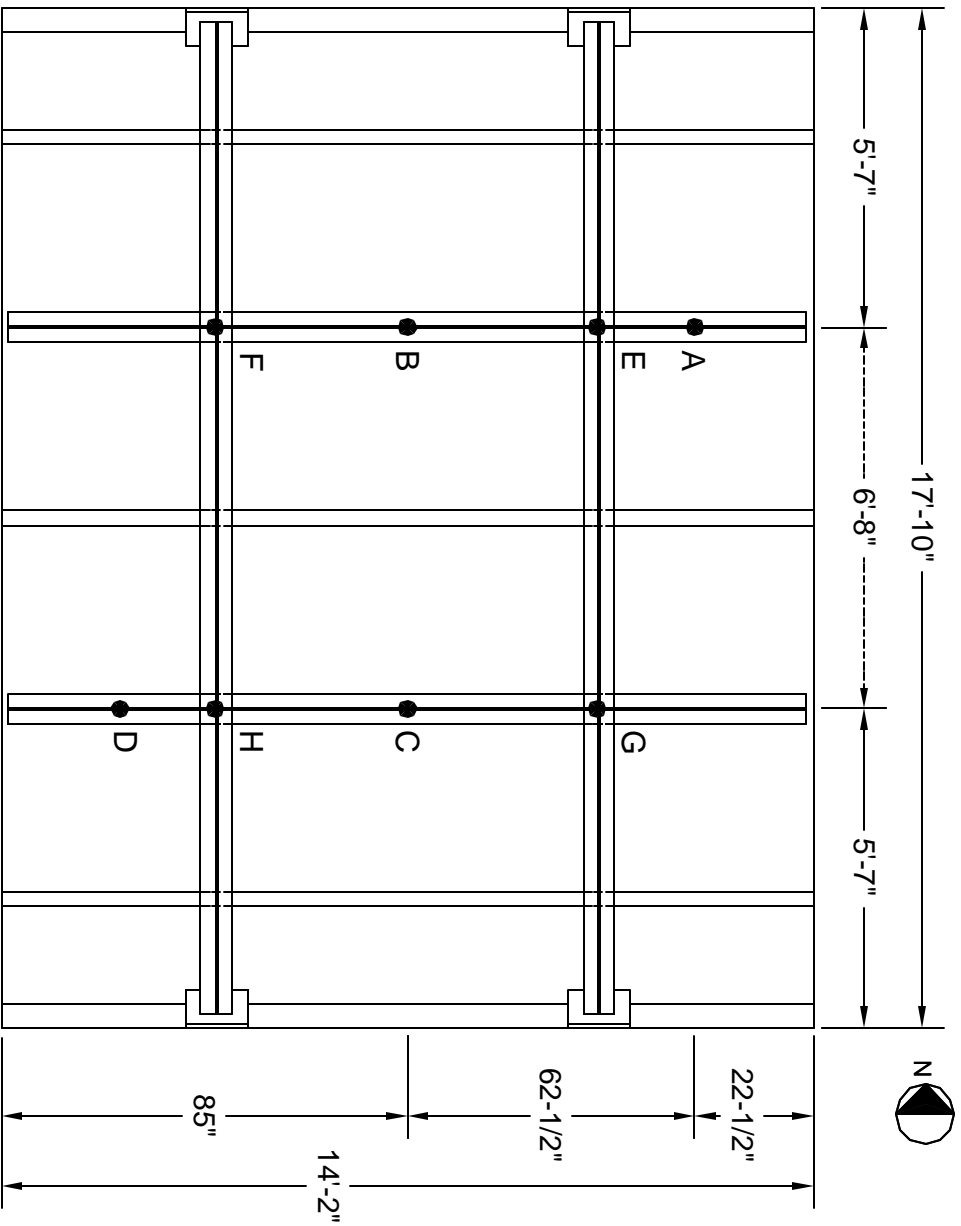

Bridging Truss Thermocouple Locations

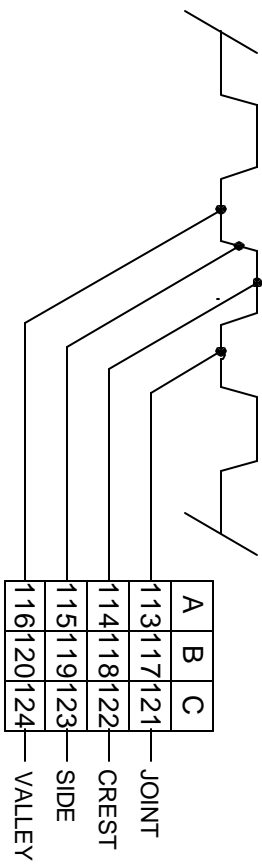
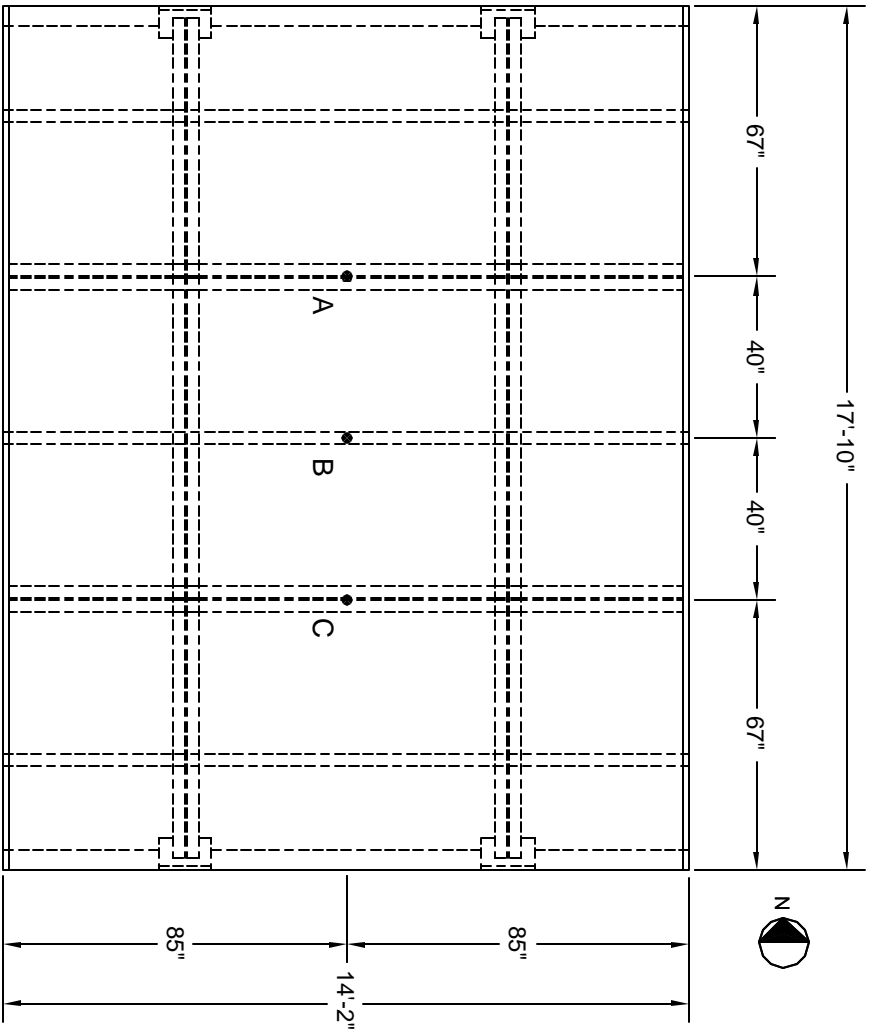

Note: Dimensions for locations may vary slightly depending on deck valley and crest occurrence in actual construction

Steel Deck Thermocouple Locations

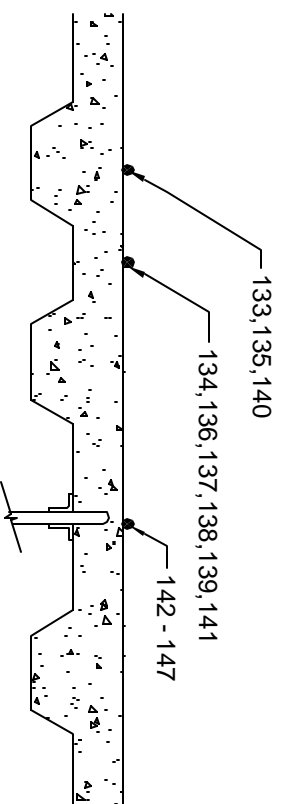
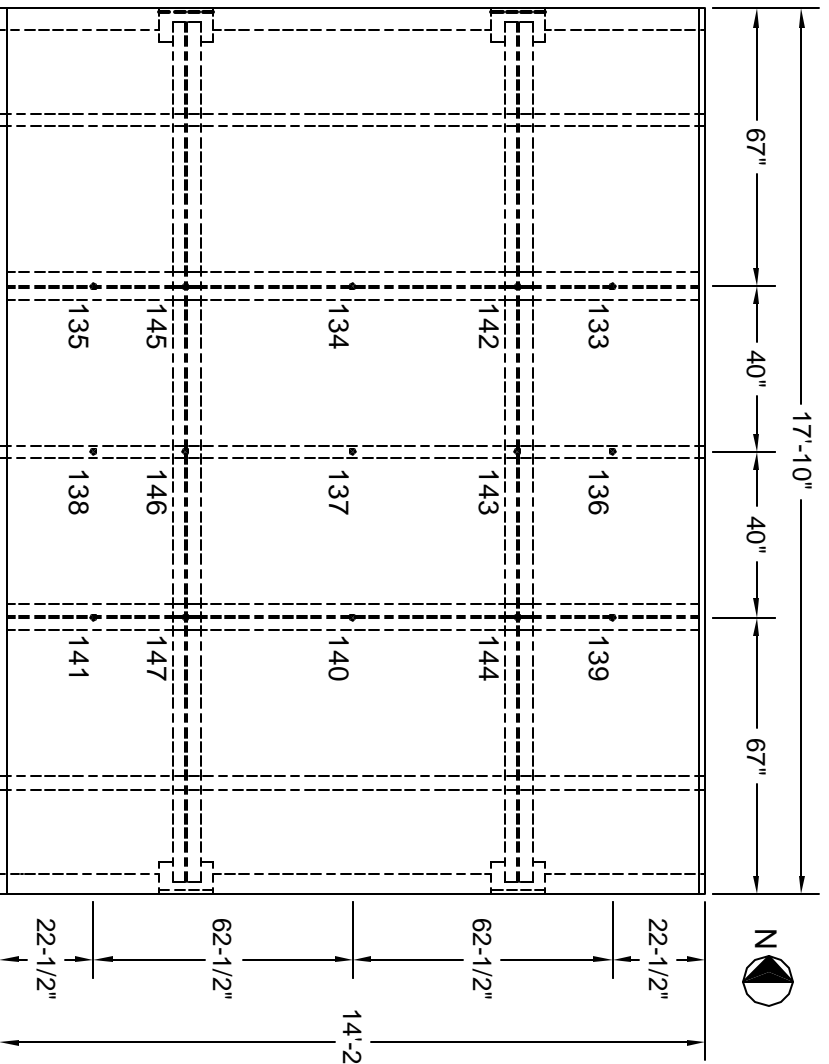

Note: Dimensions for locations may vary slightly depending on deck, valley and crest occurrence, and main truss knuckle location in actual construction

Unexposed Surface Thermocouple Locations

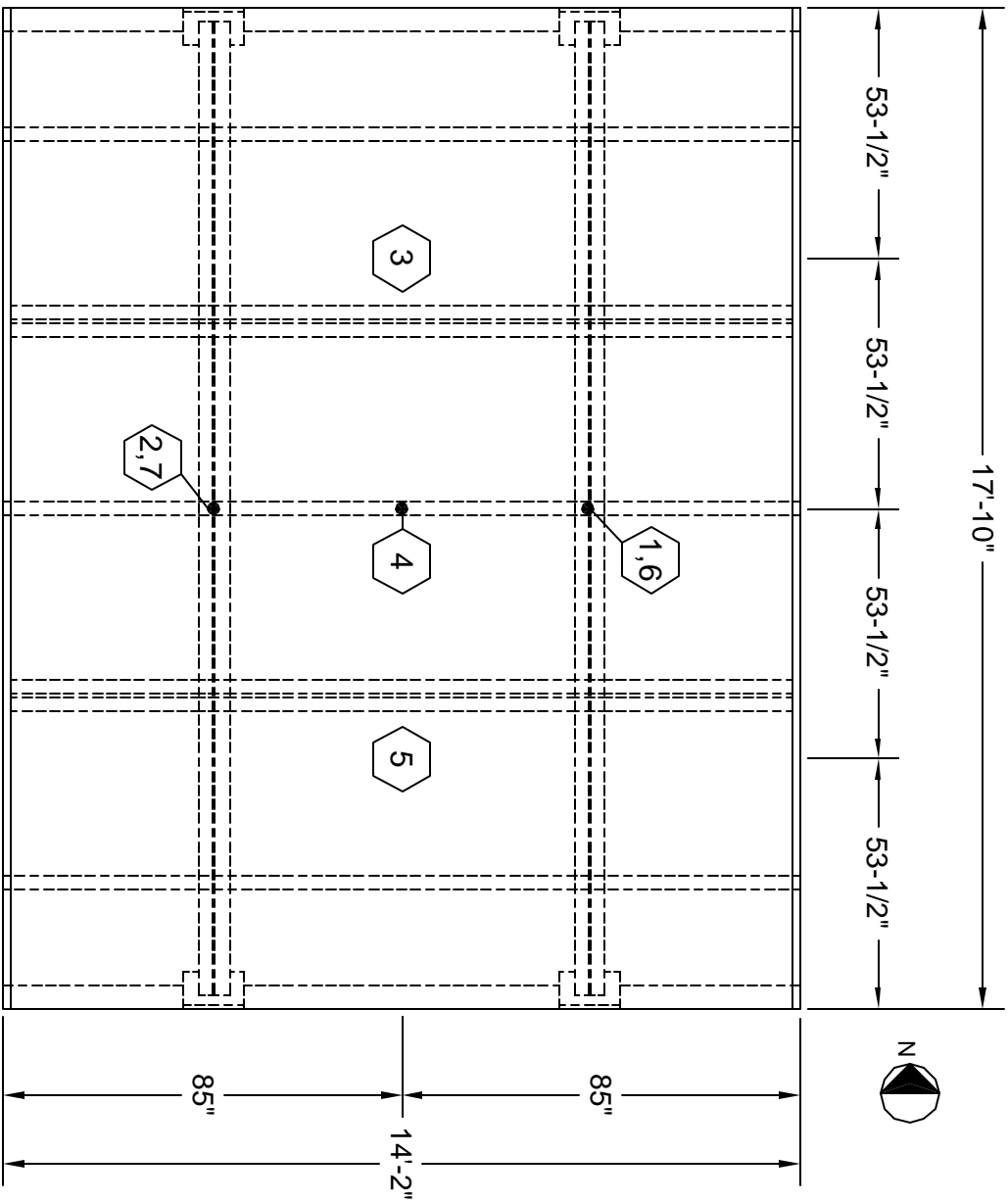

Nos. 1-5 on unexposed surface
 Nos. 6 & 7 on bottom chord of main truss

Deflection Transducer Locations

This page intentionally left blank.

Appendix G
TRUSS CALCULATION SHEETS

This page intentionally left blank.

WORLD TRADE CENTER
FLOOR GRID TRUSSES
DESIGN DATA

Truss Mk. 2C32T5-358

Truss Component Mk. C32T5-358

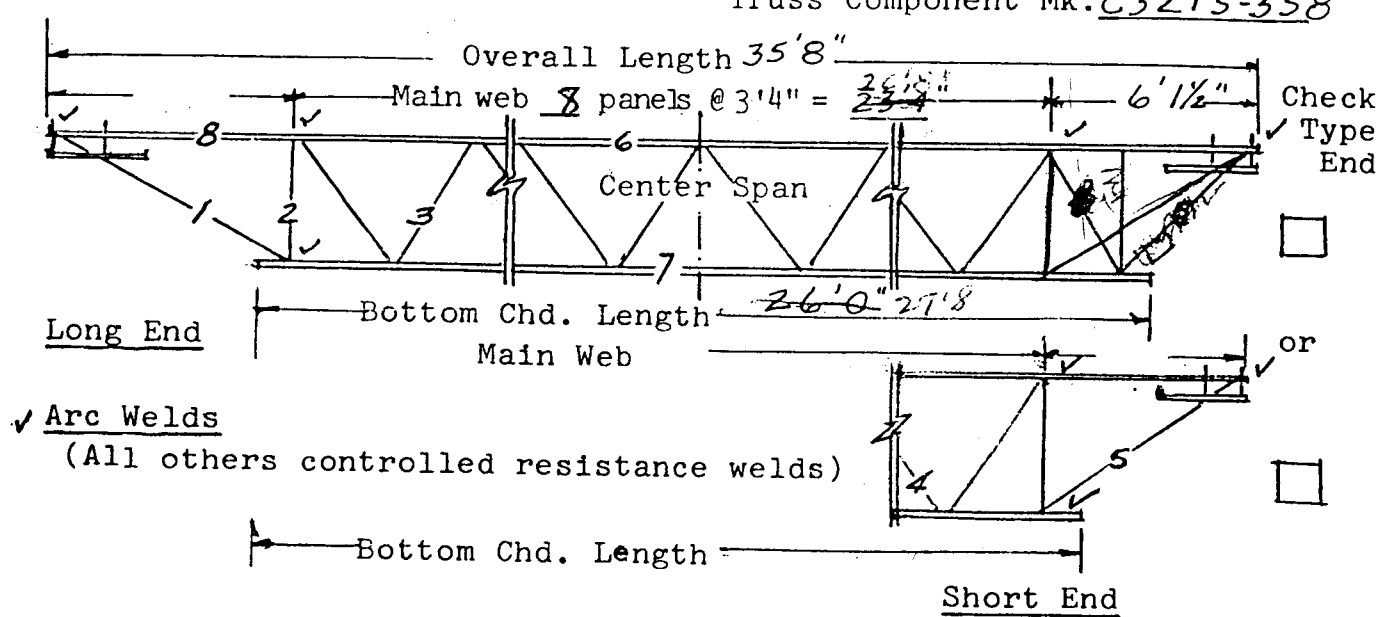

NOTES:

Main Web - Continuous uniform section throughout Member Mk. 3.
(Top chord fillers same section as Main Web - at midpoint NONE
center web panels minimum.)

Vertical Struts Mk. 2 - Same size as main web.

End Bearing Struts - Same size as main web.

Composite Type - Webs extend above top chord 3 ".

MEMBERS REQUIRED PER TRUSS COMPONENT S _____ or C

<u>Member</u>	<u>Mk.No.</u>	<u>Grade of Steel</u>	<u>Size</u>	<u>Total Length Member</u>	<u>Weight Member</u>
Top Chord	6-8	A-441	2-2" x 1 1/2" x 0.25" $\frac{1}{4}$		
Bottom Chord	7	A-36	2-2" x 1 1/2" x 0.25" $\frac{1}{4}$		
Main Web	3	A-36	0.92" DIA.		
Compression Web	4	A-441	0.98" DIA.		
Vertical End Struts	2	A-36	0.92" DIA.		
Long End Diagonal	1	A-441	0.92" DIA.		
Short End Diagonal	5	A-441	0.92" DIA.		

WORLD TRADE CENTER
FLOOR GRID TRUSSES
DESIGN DATA

TRUSS UNIT MARKED 2C32T5 Refer to drawings ST 101,6,8.

Clearspan "L" = 34.83 ft. Spacing = 6.67 ft.

Applicable Total Moment = 1,920,000 inch pounds.

Based on 154 lbs./sq. ft. Total Load "w". [31' PARTIAL
LOADING]

Applicable End Reaction = 18,000 pounds.

Based on 154 lbs./sq. ft. Total Load "w".

Applicable Total Constr. Moment = 585,000 inch pounds.

Based on 46 lbs./sq. ft. Construction Load.

Applicable Constr. End Reaction = 5470 pounds.

Based on 46 lbs./sq. ft. Construction Load.

"V" Shear at End Panel = 14,920 pounds. ED = 3.0 ft.

WEB MEMBER #1 Distance from End Panel = 0.0 ft.

Applicable Shear V_x = 14,920 lbs. f_y = 50,000 psi

Slope = 2.65 f_s = 30,000 psi

l = — in. f_{sc} = — psi

Reqd. Area = 1.32 sq. in. Use 2-0.92" DIA Area = 1.33 sq. in.

WEB MEMBER #2 Distance from End Panel = 0.0 ft.

Applicable Shear V_x = 14,920 lbs. f_y = 36,000 psi

Slope = 1.00 f_s = — psi

l = 26.0 in. f_{sc} = 11,200 psi

Reqd. Area = 1.33 sq. in. Use 2-0.92" DIA Area = 1.33 sq. in.

WEB MEMBER #3 Distance from End Panel = 4.87 ft.

Applicable Shear V_x = 9,920 lbs. f_y = 36,000 psi

Slope = 1.162 f_s = — psi

l = 30.0 in. f_{sc} = 8,750 psi

Reqd. Area = 1.32 sq. in. Use 2-0.92" DIA Area = 1.33 sq. in.

WEB MEMBER #4 Distance from End Panel = 3.21 ft. (ED = 2.08')

Applicable Shear $V_x = \underline{12,570}$ lbs. $f_y = \underline{50,000}$ psi

Slope = 1.162 $f_s = \underline{\quad}$ psi

$l = \underline{30.0}$ in. $f_{sc} = \underline{9,970}$ psi

Reqd. Area = 1.47 sq. in. Use 2-0.98" DIA Area = 1.51 sq. in.

WEB MEMBER #5 Distance from End Panel = 0.0 ft. (ED = 2.08')

Applicable Shear $V_x = \underline{15,865}$ lbs. $f_y = \underline{50,000}$ psi

Slope = 1.90 $f_s = \underline{30,000}$ psi

$l = \underline{\quad}$ in. $f_{sc} = \underline{\quad}$ psi

Reqd. Area = 1.01 sq. in. Use 2-0.92" DIA Area = 1.33 sq. in.

CHORD MEMBER #6 Consists of 4-2" x 1/2" x 0.25" Angles

Construction Load Design Area = 3.60 sq. in.

Applicable Moment = 585,000 in. lbs. $f_y = \underline{50,000}$ psi

$l = \underline{33.375}$ in. $f_s = \underline{\quad}$ psi

$r_x = \underline{0.44}$ in. $f_{sc} = \underline{12,930}$ psi

$r_z = \underline{0.31}$ in. (with fillers in middle 60% of span)

$\frac{l}{r_x} = \underline{75.8}$

$\frac{l}{r_z} = \underline{107.5}$

$\frac{f_a}{F_a} + \frac{f_b C_m}{F_b (1 - \frac{f_a}{F_e})} = \underline{0.477}$ less than 1

$f_a = \underline{5,800}$ psi

$F_a = \underline{12,930}$ psi

$f_b = \underline{748}$ psi

$F_b = \underline{30,000}$ psi

$F_e = \underline{25,950}$ psi

Use 4-2" x 1/2" x 0.25" X's Area = 3.60 sq. in.

CHORD MEMBER #7 Consists of 4-2" x 1/2" x 0.25" Angles

Total Load Design Area = 3.60 sq. in.

CHORD MEMBER #7 (CONTD.)

Applicable Moment = 1,920,000 in lbs. $f_y = \underline{36,000}$ psi

$D_t = \underline{33.00}$ in.

$f_s = \underline{22,000}$ psi

$B_{eff} = \underline{64.00}$ in.

$f_{sc} = \underline{\quad}$ psi

$t = \underline{4.00}$ in.

$y_1 = \underline{2.00}$ in.

$d_2 = \underline{2.46}$ in.

$y_2 = \underline{4.44}$ in.

$d_3 = \underline{25.66}$ in.

$y_3 = \underline{32.56}$ in.

$c_1 = \underline{6.90}$ in.

$d_1 = \underline{4.90}$ in.

$c_2 = \underline{26.10}$ in.

$$I_s = \sum [(I_c + A_c d_1^2) + (I_{TCA} + A_{TCA} d_2^2) + I_{BCA} + A_{BCA} d_3^2]$$

$$\bar{y} = \frac{\sum (A_c y_1 + A_{TCA} y_2 + A_{BCA} y_3)}{\sum (A_c + A_{TCA} + A_{BCA})}$$

$\bar{y} = \underline{6.90}$ in.

$I_s = \underline{2826}$ in.⁴ (2C32T5)

Resisting Moment = $f_s \times \frac{I_s}{c_2} = \underline{2,380,000}$ in. lbs.

Use 4-2" x 1/2" x 0.25" L's Area = 3.60 sq. in.

Composite Design Top Chord Check

Total Load Design

$f_c = \underline{3,000}$ psi

Applicable Moment = 1,920,000 in. lbs.

$f'_c = \underline{1,350}$ psi

$f'_{cc} = \frac{M_{ca}}{15I_s} = \underline{312}$ psi

CHORD MEMBER #8Consists of 4-2" x 1/2" x 0.25" Angles

Area = 3.60 sq. in.

(SAME AS MEMBER 6)

Appendix H
UNRELIABLE DATA

This page intentionally left blank.

Test 1

Test Time (min)	Location	Unreliable Data
0	Unexposed Surface	Thermocouple 133
1	Bottom Chord Deflection	Deflection 11
1	West Instrumentation	Plate Thermocouple
15	Steel Deck	Thermocouple 123
18	Steel Deck	Thermocouple 126
20	Steel Deck	Thermocouple 122
21	West Instrumentation	Radiometer Thermocouple
23	West Instrumentation	Radiometer
27	East Instrumentation	Radiometer Thermocouple
28	Steel Deck	Section C-C
32	Steel Deck	Section A-A
39	East Instrumentation	Radiometer
50	Unexposed Surface	Thermocouple 145
52	West Instrumentation	Aspirated Thermocouple
68	North Main Truss	Thermocouple 40
68	North Main Truss	Thermocouple 18
68	North Main Truss	Thermocouple 19
68	North Main Truss	Thermocouple 2
68	North Main Truss	Thermocouple 32
68	North Main Truss	Thermocouple 8
69	North Main Truss	Thermocouple 3
69	North Main Truss	Thermocouple 72
70	North Main Truss	Section A-A
70	Unexposed Surface	Thermocouple 139
72	North Main Truss	Thermocouple 33
73	North Main Truss	Thermocouple 17
73	East Bridging Truss	Thermocouple 95
74	North Main Truss	Thermocouple 36
76	North Main Truss	Section E-E
78	Bottom Chord Deflection	Deflection 14
78	Steel Deck	Thermocouple 131
79	South Main Truss	Section B-B
82	North Main Truss	Thermocouple 35
83	West Bridging Truss	Thermocouple 90
84	South Main Truss	Thermocouple 13
86	South Main Truss	Thermocouple 11
86	South Main Truss	Thermocouple 14
87	South Main Truss	Thermocouple 15
87	South Main Truss	Thermocouple 12
87	South Main Truss	Thermocouple 16
87	South Main Truss	Thermocouple 10
89	Unexposed Surface Deflection	Deflection 1
89	Unexposed Surface Deflection	Deflection 3
90	South Main Truss	Thermocouple 9
90	East Bridging Truss	Thermocouple 94
90	Steel Deck	Thermocouple 132
93	Bottom Chord Deflection	Deflection 15

Test Time (min)	Location	Unreliable Data
94	North Main Truss	Thermocouple 22
94	North Main Truss	Thermocouple 20
95	North Main Truss	Section C-C
96	Unexposed Surface Deflection	Deflection 4
96	Unexposed Surface Deflection	Deflection 6
100	Bottom Chord Deflection	Deflection 13
102	Steel Deck	Thermocouple 121
103	North Main Truss	Thermocouple 6
108	Unexposed Surface Deflection	Deflection 5
108	Unexposed Surface Deflection	Deflection 2
111	South Main Truss	Thermocouple 84
111	Bottom Chord Deflection	Deflection 10
111	Bottom Chord Deflection	Deflection 12
111	Steel Deck	Thermocouple 125
111	Unexposed Surface	Thermocouple 144
111	Unexposed Surface	Thermocouple 140
111	Unexposed Surface	Thermocouple 141
112	Unexposed Surface	Thermocouple 138
114	Unexposed Surface	Thermocouple 134

Test 2

Test Time (min)	Location	Unreliable Data
0	Steel Deck	Thermocouple 129
0	Steel Deck	Thermocouple 123
0	Steel Deck	Thermocouple 124
0	Steel Deck	Thermocouple 131
4	Steel Deck	Thermocouple 121
18	Steel Deck	Thermocouple 127
21	Steel Deck	Thermocouple 125
32	South Main Truss	Thermocouple 31
40	North Main Truss	Thermocouple 17
43	West Bridging Truss	Thermocouple 99
43	West Bridging Truss	Section C-C
43	West Instrumentation	Aspirated Thermocouple
46	South Main Truss	Thermocouple 30
46	Bottom Chord Deflection	Deflection 15
49	Steel Deck	Thermocouple 132
65	Steel Deck	Thermocouple 122
73	Steel Deck	Thermocouple 130
74	Unexposed Surface Deflection	Deflection 6
77	Steel Deck	Thermocouple 128
82	Unexposed Surface Deflection	Deflection 1
82	Unexposed Surface Deflection	Deflection 2
83	Bottom Chord Deflection	Deflection 11
84	Unexposed Surface Deflection	Deflection 5
87	North Main Truss	Thermocouple 18
87	North Main Truss	Thermocouple 23
88	North Main Truss	Thermocouple 20
88	North Main Truss	Thermocouple 24
93	East Instrumentation	Aspirated Thermocouple
96	West Bridging Truss	Thermocouple 92
105	Bottom Chord Deflection	Deflection 14
107	Unexposed Surface	Thermocouple 137
109	South Main Truss	Thermocouple 62
110	North Main Truss	Thermocouple 21
110	Unexposed Surface Deflection	Deflection 7
110	Unexposed Surface Deflection	Deflection 3
110	Unexposed Surface Deflection	Deflection 4
112	West Bridging Truss	Thermocouple 120
113	East Bridging Truss	Thermocouple 96
113	East Bridging Truss	Section A-A
114	Bottom Chord Deflection	Deflection 13
116	East Bridging Truss	Thermocouple 116
119	East Bridging Truss	Thermocouple 95
121	Steel Deck	Thermocouple 126
122	East Bridging Truss	Thermocouple 93
124	East Bridging Truss	Thermocouple 103
128	North Main Truss	Thermocouple 7
128	North Main Truss	Thermocouple 39

Test Time (min)	Location	Unreliable Data
128	North Main Truss	Thermocouple 34
128	North Main Truss	Thermocouple 38
128	West Bridging Truss	Thermocouple 112

Test 3

Test Time (min)	Location	Unreliable Data
0	East Main Truss	Thermocouple 58
1	Steel Deck	Thermocouple 126
1	Steel Deck	Thermocouple 127
1	North Instrumentation	Aspirated Thermocouple
2	Steel Deck	Thermocouple 128
2	Steel Deck	Thermocouple 125
8	Steel Deck	Thermocouple 129
19	Steel Deck	Thermocouple 132
71	East Main Truss	Thermocouple 37
72	North Instrumentation	Calorimeter
83	Unexposed Surface Deflection	Deflection 7
83	Bottom Chord Deflection	Deflection 14
84	Unexposed Surface	Thermocouple 142
85	Steel Deck	Thermocouple 121
87	Unexposed Surface	Thermocouple 143
90	West Main Truss	Thermocouple 13
95	West Main Truss	Thermocouple 46
95	West Main Truss	Thermocouple 48
96	West Main Truss	Thermocouple 44
96	West Main Truss	Thermocouple 42
100	West Main Truss	Thermocouple 45
100	West Main Truss	Thermocouple 47
100	East Main Truss	Thermocouple 17
101	North Bridging Truss	Thermocouple 93
101	North Bridging Truss	Section B-B
101	North Bridging Truss	Thermocouple 96
101	North Bridging Truss	Thermocouple 95
105	Unexposed Surface	Thermocouple 134
107	North Bridging Truss	Thermocouple 116
111	East Main Truss	Thermocouple 33
111	East Main Truss	Thermocouple 36
115	West Main Truss	Thermocouple 59
115	East Main Truss	Thermocouple 76
115	East Main Truss	Section E-E
116	Unexposed Surface	Thermocouple 140
132	Unexposed Surface	Thermocouple 139
140	North Bridging Truss	Thermocouple 104
141	North Bridging Truss	Thermocouple 103
141	North Bridging Truss	Section D-D
165	South Bridging Truss	Thermocouple 91
165	South Bridging Truss	Section A-A
167	South Bridging Truss	Thermocouple 92
171	South Bridging Truss	Thermocouple 99
171	South Bridging Truss	Section C-C
175	South Bridging Truss	Thermocouple 100
175	South Bridging Truss	Thermocouple 119
181	South Bridging Truss	Thermocouple 120

Test Time (min)	Location	Unreliable Data
182	North Bridging Truss	Thermocouple 115
191	North Bridging Truss	Thermocouple 94
193	South Bridging Truss	Thermocouple 112
193	South Bridging Truss	Section F-F
194	South Bridging Truss	Thermocouple 110
195	West Main Truss	Thermocouple 43
196	West Main Truss	Thermocouple 67
202	North Bridging Truss	Section E-E
202	North Bridging Truss	Thermocouple 108
206	South Bridging Truss	Thermocouple 90

This page intentionally left blank.

Appendix I

UNITS CONVERSIONS

U.S. Customary Units to S. I. units

°F	=	°C ×(9/5)+32
1 in.	=	25.4 mm
1 in. ²	=	645.2 mm ²
1 ft	=	0.3048 m
1 ft ²	=	0.0929 m ²
1 lb	=	4.448 N
1 kip	=	4.448 kN
1 fb/ft	=	14.59 kN/m
1 psi	=	0.006895 N/mm ² or 0.006895 MPa
1 ksi	=	6.895 MPa
1 psf	=	0.04788 kN/m ²
1 pcf	=	0.1571 kN/m ³
1 BTU/s	=	1.055 kW
1 BTU/s/ft ²	=	11.357 kW/m ²

S. I. Units to U. S. Customary Units

$$^{\circ}\text{C} = (^{\circ}\text{F}-32) \times (5/9)$$

$$1 \text{ mm} = 0.0394 \text{ in.}$$

$$1 \text{ m} = 3.281 \text{ ft}$$

$$1 \text{ MPa} = 145.0 \text{ psi}$$

$$1 \text{ kN/m}^2 = 20.88 \text{ lb/ft}^2 \text{ (psf)}$$

$$1 \text{ kW} = 0.948 \text{ BTU/s}$$

$$1 \text{ kW/m}^2 = 0.088 \text{ BTU/s/ft}^2$$

Table I-1. Temperature conversions.

°F	°C
70	21
100	38
200	93
300	149
400	204
500	260
600	316
700	371
800	427
900	482
1000	538
1100	593
1200	649
1300	704
1400	760
1500	816
1600	871
1700	927
1800	982
1900	1038
2000	1093